

Featuring:
• Amigo J9

AMIGO OWNER'S

MANUAL

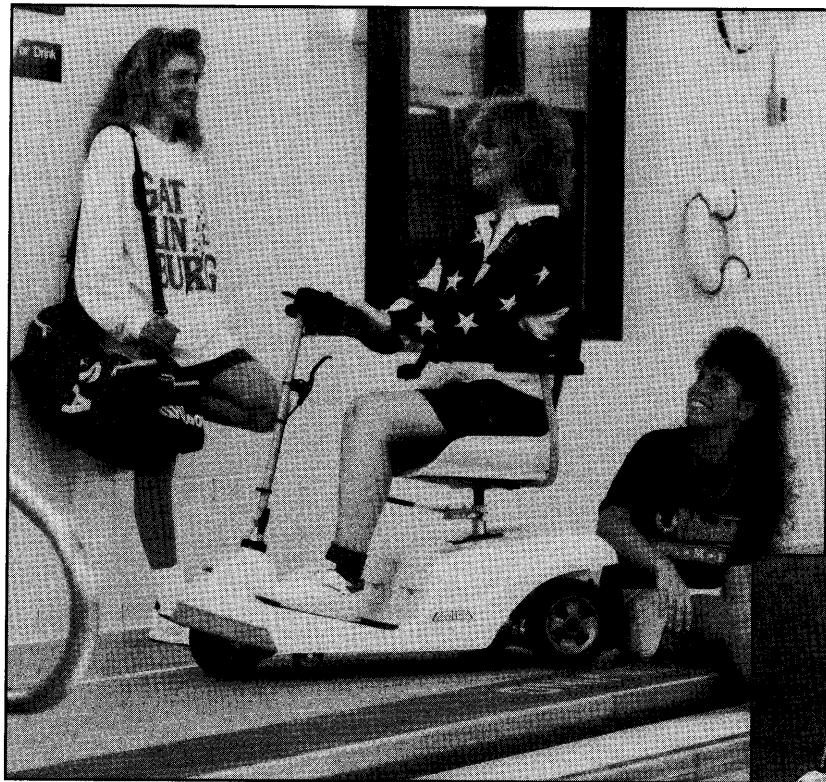

*Rear
Wheel
Drive*



Welcome and First Things First	2
Safety First	4
Getting Down to Basics	6
■ Assembly Instructions	7
Now It's Your Turn	11
■ Operating Your Amigo	12
■ Helpful Hints for Everyday Use	15
Amigo, A Friend for Life	18
■ Maintenance	19
■ Service	21
■ Warranties	21
Amigo J9 (Exploded View Diagrams)	24
(Parts List)	26
Wiring Diagram	28
Amigo Mobility Center® Listing	31
International Distributors	32

CONTENTS

TABLE OF

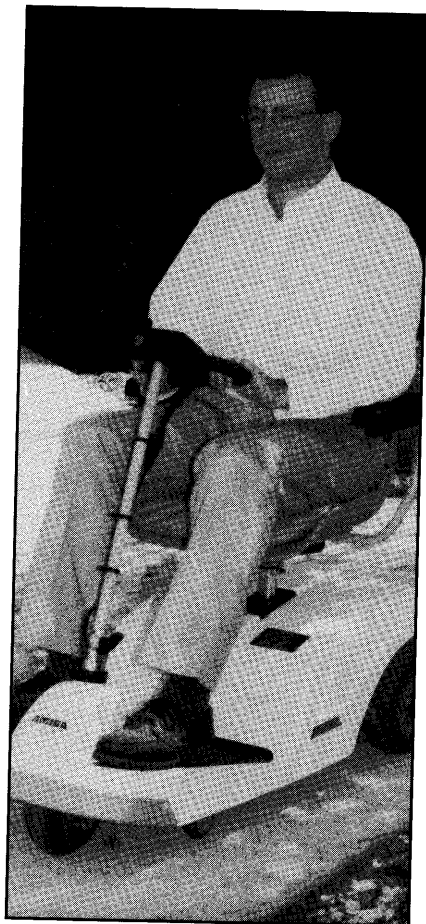

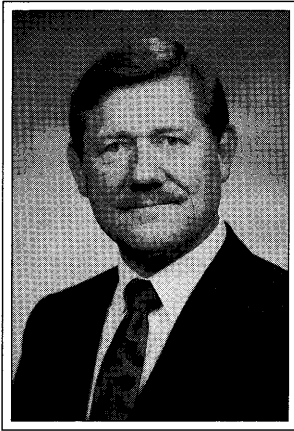

Allan R. Thieme

WELCOME

Welcome to the Amigo family of active and independent people. For thousands of individuals around the world, the AMIGO J9 provides the opportunity to enjoy life more fully. We are confident that the following instructions and helpful hints will make the Amigo an extremely useful and reliable "friend." Because we are concerned about your health and safety, please read this manual carefully before operating your Amigo. When you learn how to use the Amigo properly, you will discover a world of enjoyment and independence.

As a member of the Amigo family, you will receive the ***Friendly Wheels***, our magazine written especially for and about Amigo owners. The ***Friendly Wheels*** will keep you informed about new products and accessories, helpful hints, service tips, special offers and much more!

Please write us and include a photograph of yourself and your Amigo. Your letters are a source of inspiration to us. As you use your Amigo, be sure to share your helpful hints and operating suggestions with us so we can pass them on to other owners.

Wishing you happiness and good health from all of us at Amigo Company.

&

**FIRST
THINGS FIRST**

Sincerely,
Allan R. Thieme
President & Founder

- CHECK YOUR ORDER
- COMPLETE AND RETURN WARRANTY CARD
- DO NOT OPERATE YOUR AMIGO UNTIL YOU HAVE COMPLETELY READ THIS OWNER'S MANUAL
- REPAIR HOTLINE 1-800-248-9131

For your convenience and understanding, signal words are defined below:

⚠ DANGER

*Danger is used to indicate the presence of a hazard which **will** cause **severe** personal injury, death, or a substantial property damage if the warning is ignored.*

⚠ WARNING

*Warning is used to indicate the presence of a hazard which **can** cause **severe** personal injury, death, or substantial property damage if the warning is ignored.*

⚠ CAUTION

*Caution is used to indicate the presence of a hazard which **will** or **can** cause minor personal injury or property damage if the warning is ignored.*

NOTICE: This book pertains to the Amigo J9.

Do not operate your Amigo until you have completely read this Owner's Manual.

Amigo Mobility International, Inc. (AMI) disclaims any responsibility for personal injury or property damage resulting from the improper or unsafe use of its products.



Safety Suggestions

Use the following rules as guidelines for the safe operation and use of your Amigo. Should you have any questions about the safe operation or use of your Amigo, please contact Amigo Mobility International, Inc. (AMI) or your local Amigo representative. If you are in doubt about your ability to operate your Amigo, consult your personal physician.

SAFETY



FIRST

PERSONAL SAFETY INSTRUCTIONS!

- **Keep legs on the platform while driving the Amigo.**
- **Drive slowly while turning and on inclines.**
- **Drive straight up and down inclines.**
- **Do not park on inclines/declines.**
- **Your Amigo is restricted to one occupant.**
- **Occupant must remain seated while Amigo is in operation.**
- **Lock seat in forward position before operating Amigo.**
- **Use of this product by persons exceeding 175 lbs. is not recommended. Use of this product by persons exceeding 250 lbs. voids the Amigo J9 warranty.**
- **Armrests and handlebar must be in riding position while operating your Amigo.**

- Make sure the batteries are held securely in place.
- Use dual wheels for added stability if you purchased this option.
- Do not drive over or off obstacles more than 1 inch high. This could be unsafe and could damage your Amigo J9.
- Do not make sharp, abrupt turns at high speeds or going down an incline.
- Avoid sudden starts while the handlebar is turned sharply.
- Avoid inclines or ramps having a rise of more than 1 inch per foot (Federal standard for wheelchair ramps).
- Do not operate on streets or other areas with vehicular traffic.
- When driving over bumps, dips or inclines, approach them at a 90-degree angle.
- Do not back onto any changes in the surface or grade.
- Do not sit on the Amigo in a moving vehicle.
- When operating under low light conditions, the user should equip the Amigo with proper lighting.
- When stopped or transferring, always turn the key switch OFF on your Amigo J9.

⚠ CAUTION

Turning the key "OFF" while in motion will bring the Amigo J9 to an abrupt stop.

- **TO STOP IN EMERGENCY SITUATIONS ONLY, USE THE SAFETY BRAKE. To disengage the brake, reverse the direction of your Amigo J9.**

Note: Repeated use of the safety brake will result in excessive tire wear.

- Never ride your Amigo J9 with the brake bracket underneath the J9 removed. It provides critical support for the J9 platform.

⚠ CAUTION

Do not use a garden hose to clean your tires. Water may get into the controller and cause electronic malfunctions.

- When transferring off your Amigo, make sure the seat lock is in the locked position.
- To transport the Amigo, **DO NOT** remove handle from steering column. Instead, loosen the knob near the bottom of the handle so you can fold the handle down to the base. Place handle down so that the HI/LO knob will not become damaged. Tighten the knob to secure the handle.
- When utilizing public transportation, do not sit on your Amigo while it is being lifted onto the vehicle. Where this is not possible, a proper hold-down system should be provided.

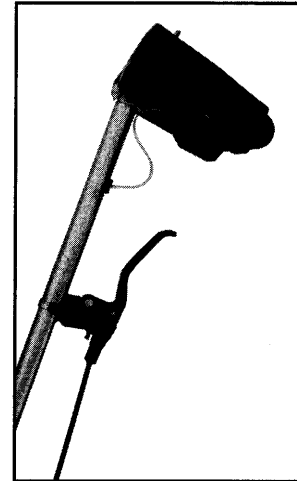



GETTING



DOWN TO BASICS

- **ASSEMBLY INSTRUCTIONS**
 - Handle
 - Seat Installation
 - Seat Positioning
 - Dual Wheels
- **BATTERY INFORMATION AND CHARGER INSTRUCTIONS**
 - Battery Maintenance
 - General Maintenance
 - Sealed Batteries
 - Quick Battery Recharging Instructions
 - Battery Charger Troubleshooting
- **CIRCUIT BREAKER AND FUSE REPLACEMENT INSTRUCTIONS**

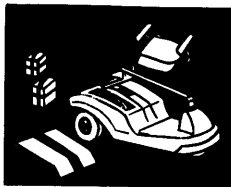

Assembly Instructions

• HANDLE ADJUSTMENT

To adjust the angle of the handle, loosen the lower knob to separate the meshed teeth. Move the handle into the desired position and tighten the knob (Figure 1).

• SEAT INSTALLATION

1. Unlock the seat lock.
2. Insert the upper seat post into the opening of the lower seat post.
3. Spin seat around to make sure it rotates freely.
4. To lock the seat, pull the seat lock lever toward the rear of the seat.

To raise or lower your seat height, remove the nut and bolt that holds the seat collar in place on the seat post, then adjust and reinstall in one of the holes on the seat post.

⚠ CAUTION

It is recommended that the seat lock be installed in the second or third hole positioned from the seat. If you desire to put your seat higher than this, you must have stability wheels or dual wheels on your Amigo.

• STABILITY WHEELS

Front stability wheel attachments provide additional stability and are required for use on rough or uneven surfaces. The stability attachment mounted below the base just behind the front wheel should not be removed. It offers increased stability without making your Amigo wider.

⚠ CAUTION

Do not drive at full speed into any fixed obstacles or objects as this may cause cracking of the base or damage to the stability wheel attachment.

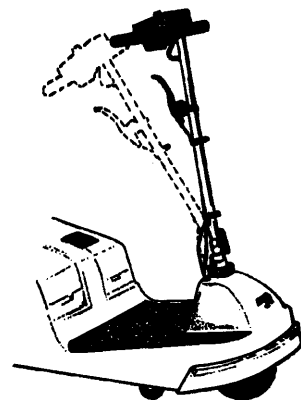
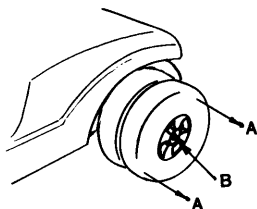
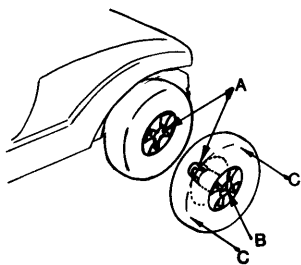

Figure 1



- A. Pull.
- B. Press the button on the quick release pin.

Figure 2



- A. Align lugs on the dual wheel insert with lugs on the drive wheel insert.
- B. Press the button on the quick release pin.
- C. Push the wheels together until the quick release pin snaps out.

Figure 3

• DUAL WHEELS (Optional)

Dual wheels provide additional stability and are required on rough or uneven surfaces.

Removal of Dual Wheels :

Dual wheels on the Amigo J9 can be removed indoors for greater maneuverability in narrow areas.

Please refer to Figure 2 for the following:

Grasp the outer wheel with both hands while depressing the small button at the center of the quick release pin with your thumb. Pull the wheel toward you to remove.

Installation of Dual Wheels :

Please refer to Figure 3 for the following:

1. Depress button in the quick release pin in the center of the outer dual wheel. Holding the dual wheel and pin, bring it toward the drive wheel.
2. Guide the bore coupling into the center hole of the inner drive wheel.
3. Turn the outer wheel so that the bore coupling grooves line up with

the grooves in the coupling on the drive wheel.

4. Push the outer wheel in until the button of the quick release pin snaps out and the wheel cannot turn in either direction separate from the inner wheel.
5. Make sure the wheel is securely attached. Try to pull out the dual wheel to insure it will not come off.

NOTE: To ease the removal and installation of the Dual Wheels (without the occupant), tilt the J9 to either side.

• BATTERY INFORMATION AND CHARGER INSTRUCTIONS

ATTENTION

Your batteries have been placed backwards in the battery holder for safety during shipping. You will have to pull them out, turn them around and put them back in the battery holder to operate your Amigo.

Spill-proof and maintenance-free, 12-volt batteries have been supplied. *Always turn*

your Amigo OFF before removing and installing batteries.

For maximum range and life, it is recommended to fully charge the batteries before using. Extended charging is good for the batteries. The batteries will not overcharge.

It is a popular misconception that batteries should be deeply discharged before recharging. This is not the proper procedure for batteries. They can actually be damaged if they are discharged too deeply before recharging.

Charge your batteries daily when the Amigo is used.

A sophisticated battery indicator and battery diagnostic system are incorporated into the touch panel of your Amigo. The battery icon LED will be lit whenever the key is in the "ON" position. However, if the Amigo is inactive for more than 23 minutes, the power is automatically turned off. To reactivate your Amigo, switch it "OFF" and then "ON" again to regain full function. This feature will conserve battery power so you do not have to remember to switch your power off when your Amigo is idling or inactive for extended periods of time.

Charging Procedure for Batteries on the J9:

Park near an AC outlet. Remove the battery top cover on the right hand side of the J9. Pull out the charge cord and insert it into the wall outlet. Observe the LED light on the handle control panel. As soon as the charger is plugged in and the batteries are in the charging mode, the LED light will blink for a short period of time (approximately 20 seconds) and then glow continuously until the batteries are fully charged, then the red light will flash. While in the charging mode, your Amigo cannot be driven.

The charging cycle is completed and your batteries are fully charged when the LED light is blinking while still in the charging mode.

Battery Maintenance:

See page 20 in the Maintenance Section.

⚠ CAUTION

Make sure that the wall cord is unplugged from the wall outlet before moving your Amigo.

Universal Charger Option

A Universal Charger is available on many Amigos sold outside the United States. The Universal Charger uses a range of 90 - 240 volts AC power input. This makes it possible to charge on any electrical system globally. (The Universal Charger is an option on models in the US for people who travel abroad and want this universal charging flexibility.)

Your charger is labeled identifying which charging system it uses.

⚠ CAUTION

Do not use a 24-volt charger that is configured to a 120-volt AC power input outside the US in countries using 220-volt AC power input. Damage will occur to the charger.

AMIGO

by Marjorie Spencer Darling

*I have a small electric cart
I always have in tow,
for every time I take a trip
Amigo's sure to go.
It followed me abroad this year,
it simply is terrific!
We went to the antipodes,
and to the South Pacific.
You, too, can take Amigo now
and travel many places.
No need for you
to stay at home - Go!
See new things and new faces.*

• CIRCUIT BREAKER & FUSE REPLACEMENT INSTRUCTIONS

A circuit breaker protects the wiring and battery in the event of a short circuit. If your Amigo stops, check for overloads or short circuits before continuing to operate.

The circuit breaker is under the platform between the two batteries near the seat post.

WARNING

To avoid damage to batteries during storage, **DO NOT** place them end to end with positive (+) and negative (-) terminals next to each other.

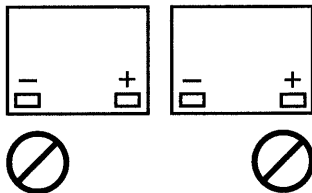

• BATTERY STORAGE

If you remove your batteries from your Amigo, put them on a surface that cannot be damaged by acid fumes. Whenever a battery is charged and discharged through a cycle, it breathes. The breathing of the battery emits acid fumes into the cloth strap that may mark surfaces it rests on for long periods of time.

NOW

**IT'S
YOUR TURN**

■ **OPERATING
YOUR
AMIGO**

- Handle Adjustments
- Driving Your Amigo
- Manual Pushing
- Optional Equipment
- Transporting
Your Amigo
- Airplane Travel
- Ground Travel

■ **HELPFUL
HINTS FOR
EVERYDAY USE**

- Bathroom
- Bedroom
- Kitchen
- Car
- Inclines
and Ramps
- Using An Elevator
- Opening Doors
- Keep Your
Amigo Shining
- Speed Controls
- Stopping



Top View of Handle

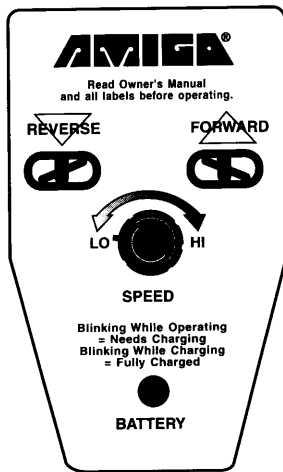

Figure 4



Operating Your Amigo

• HANDLE

Controls include: (See Figure 4) Top speed limiting dial, key lock and battery indicator light. The key lock, on the right side of the control box, will turn the power ON or OFF. The top speed may be adjusted with the knob in the middle of the control panel (See Figure 6). By turning this knob to the HI position your Amigo can drive up to 4.5 miles per hour. When the knob is set to LO position, the speed will be reduced to a slow creep, ideal for less experienced drivers and operating indoors.

THE KEY LOCK

To turn power ON insert the key and turn it counterclockwise to ON position. The key lock is on the right side of the membrane enclosure box (See Figure 5). When the power is ON,

the battery LED will light up. Your Amigo will automatically shut itself OFF after 23 minutes of inactivity. To reactivate your Amigo, switch the key lock OFF and then ON. This feature prevents battery drainage.

• DRIVING YOUR AMIGO

To move forward, pull the right side of the hand control lever toward you (Figure 7). You can also move forward by pushing the left side of the control lever away from you. By releasing the control lever, you will come to a stop approximately one second after release. To operate in reverse, pull the left side of the hand control lever toward you, or push the right side control lever away from you.

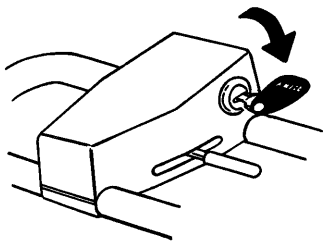
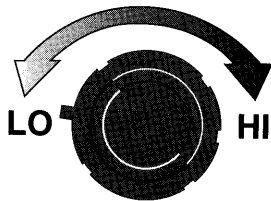

Figure 5



SPEED

Figure 6

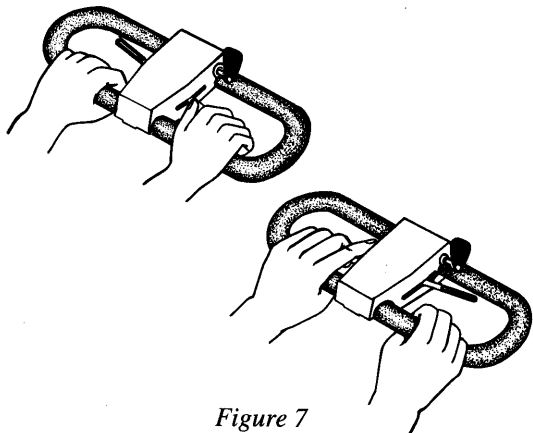

Figure 7

• **MANUAL PUSHING**

For safety and security, your Amigo is equipped with an electromagnetic brake which makes pushing your Amigo almost impossible. The J9 is equipped with a manual free-wheeling lever inside the transaxle housing. With the manual brake release, the freewheeling mode can be terminated by pushing the brake lever towards the rear of the Amigo.

• **MANUALLY TRANSPORTING YOUR AMIGO**

Your Amigo can be disassembled and transported in most car trunks (Figure 8).

1. Turn OFF your Amigo.
2. Unlock the seat and remove it completely.
3. Remove the batteries.
4. Fold handle down to platform (See page 7).
5. Lift the rear into the trunk of the vehicle and slide the Amigo into the trunk.

Note: When batteries are removed, the wheels will not rotate for safety purposes.

6. Place seat and batteries into the trunk.

Note: For proper battery storage, see page 10.

Instructions to Baggage Handlers

1. Make an instruction tag and attach it to your Platform Mobility Aid (PMA) in a conspicuous place.

2. List the following instructions:

TO ROLL:

Holding onto handle and armrest, tilt so one rear wheel is not touching the ground.

TO CARRY:

Lift by the underside of the upper body.

BATTERIES:

Located directly below the seat in plastic housing. Disconnect by lifting each battery, turning 180 degrees and placing back in battery bucket. Brass battery connectors should face towards the sides of the Amigo. Make sure the battery rod is in place.

Amigo owners say that the best way to insure proper handling is to deliver your PMA personally to the handler and explain face-to-face the instructions and add the ever-powerful statement, "This is my legs."

• LOAD YOUR AMIGO INTO YOUR CAR WITH A LIFT•ALL®

Note: For greater convenience, obtain a Lift•All® to assist you when loading and unloading. For more information on the Lift•All®, contact your local Amigo Mobility Center® or call toll-free: 1-800-248-9131. For your safety, use hold-down systems to secure your Amigo during transport. We do not recommend using the Amigo with elevated van lifts.

• AIRPLANE TRAVEL

An Airline Travel Kit (Item #300116) is available from Amigo Mobility International, Inc. It contains a battery holding strap, three "Special Handling" tags and a "Helpful Hints for Airline Travel" booklet. Nonspillable batteries are approved for travel on airplanes. When you make your reservation, notify the airline that you will be requesting an "Escort" service. This will assure you that your Amigo will be picked up and delivered at the boarding gate.

• GROUND TRAVEL

Some public transportation systems have accommodations for your Amigo, but you must transfer to a seat.



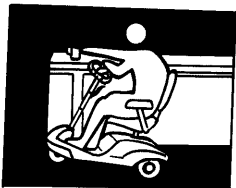

Helpful Hints for Everyday Use

• BATHROOM

In the bathroom, maneuvering room is usually limited. Position close to the toilet, swivel the seat, lock it in position and transfer.

When using the bathtub, back up parallel to the tub. Swivel the seat and place your feet in the tub. Engage seat lock and carefully transfer.

⚠ WARNING

Do not use your Amigo while taking a shower. The water may get into the controller and cause electronic malfunctions.

• BEDROOM

To transfer to the bed, back up parallel to the bed. Swivel, lock seat into position, and

ease onto the bed. If charging the batteries overnight, it may be easiest to plug in the battery charger before transferring. For added ease, when using a power seat lift, raise your seat slightly higher than the surface from which you are transferring.

• KITCHEN

For access to a refrigerator, make a parallel approach or back up to the outside of the refrigerator. Swivel the seat.

Approach a table, sink, or stove by maneuvering parallel to it. Swivel the seat to the desired position. The handle will be out of the way.



Figure 9





• CAR

To transfer to a car, make a parallel approach to the side of the car, release the door latch, and open the door as you drive forward. Back parallel to the side of the car and into the door opening. Swivel the seat and lock it in position and carefully slide onto the car seat. On the driver's side you can use the steering wheel for leverage.

• RAMPS AND INCLINES

- Always lean forward as you maneuver your Amigo up a ramp or incline of an angle equal to 1 inch of rise to 12 inches of travel length (2.54 cm of rise to 30.48 cm of travel).
- Engage your seat lock when travelling up ramps or inclines.
- Lower the speed setting to the slowest speed.

• USING AN ELEVATOR

Backing into an elevator allows you to exit forward. Be sure the elevator is level with the floor.

• OPENING DOORS

When a door opens toward you, approach at an angle and just off to one side. Grasp the door knob, reverse and pull the door open. For doors that open away from you, position the bumper against the door, close to the door-jamb on the doorknob side of the door. After you release the latch, use the bumper to push the door open.

⚠ CAUTION

*BE CAREFUL WITH GLASS DOORS
TO AVOID PERSONAL INJURY!*

• KEEP YOUR AMIGO SHINING

Clean a fabric seat with upholstery cleaner or wash with mild soap and water. Wipe the naugahyde seat clean with a damp cloth. To clean the body of your Amigo J9, use an auto glaze.

⚠ WARNING

Do not expose your Amigo to spray-on cleaning solutions and excessive moisture such as

spraying it with a garden hose, shower, or leaving it uncovered in heavy rain.

Excessive moisture around the controller or electrical connections may cause contamination of electrical circuitry, damage and malfunction as well as personal injury.

• SPEED CONTROLS

Slower speeds are recommended indoors and while learning to operate your Amigo. Higher speeds can be used when conditions allow.

• STOPPING

1. Dynamic braking will gradually bring your Amigo to a stop on a level surface.
2. The Electromagnetic Brake will stop your Amigo one to two seconds after releasing thumb control.
3. Quick stopping with your Amigo can also be accomplished by

reversing the handle control in order to reverse the direction the Amigo is travelling or the key extension tag (when hit) will shut off your Amigo. This is only recommended for stopping in emergency situations.

4. IN EMERGENCIES ONLY -

Use the safety brake located under the oval handle. To disengage the brake, reverse the direction of your Amigo.

⚠ CAUTION

THIS PROCEDURE IS NOT RECOMMENDED.

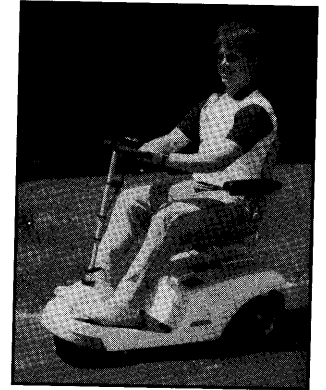



■ **MAINTENANCE**

- Daily
- Monthly
- Yearly
- Controller
- UNIPAC® Drive

■ **SERVICE**

■ **WARRANTIES**

AMIGO



**A FRIEND
FOR LIFE**



Maintenance

Minimum maintenance is required to increase your service ease and dependability. Check the following:

• DAILY

- Maintain battery charge.

• IF YOU USE YOUR AMIGO DAILY

- It is important to charge the battery daily. Charge the battery until fully charged to ensure battery operation throughout the cold weather months.

Storage Tip: Extended charging is good for the batteries. The batteries will not over-charge. Charge battery fully and store indoors in an arid environment. Do not store

on concrete since this will continue to draw on the battery. Protect your battery by placing it on a wood block instead.

• MONTHLY

- Check and clean battery terminals and the copper connections as needed with a light piece of emery cloth. Lightly pull copper spring tabs out 1/8 inch to 1/4 inch to insure successful connection when battery is replaced. If your battery hold-down bar is hard to push, coat it with a light spray of WD40.
- Clean upholstery, plastic and metal with a mild surface cleaner.
- Check to ensure the white plastic rivets on the side of the J9 body are intact. Contact your service person immediately if one is missing to replace it.

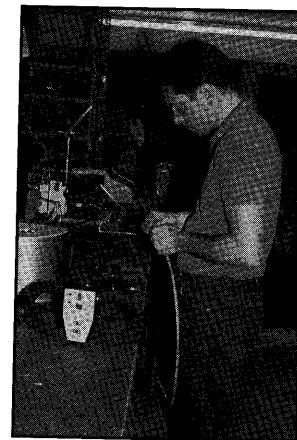

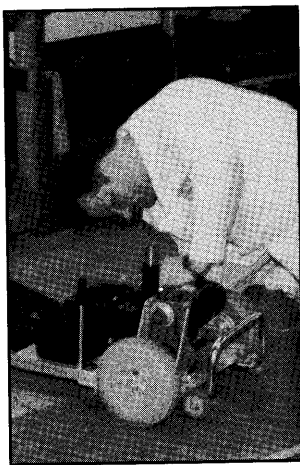

⚠ CAUTION

Keep cleaning solvents, away from electrical wires and connections.

- Make sure all fasteners are tight at all connections in the battery compartment.
- Check front wheel bearings for roughness during rotation. Replace if necessary.
- Make sure all fasteners are tight at all connections on battery box.

OPTIONAL DUAL WHEELS

- Remove wide-track dual wheels and inspect interconnecting parts of the dual wheels and drive wheels for signs of corrosion. Wipe clean and lightly coat interconnecting parts with lubricant or grease.

• 6 MONTHS

- Check the brass barrels on your batteries. If a flat spot has developed, rotate the barrel for better contact.
- Check all electrical connections for clean contact.
- Charging connection should be inspected for tight connection.

- Check tires for wear.
- Inspect seat posts for cracks or breaks in welds.
- Check the washer underneath the bolts that attach the transaxle to the upper body. Tighten the bolts if the washer is loose (See the J9 exploded diagram on page 24, Reference #259).

• YEARLY

- Have your authorized service center check your Amigo completely.

• CONTROLLER

Do not attempt to service the controller or related electronic components as you may void your warranty. Do not open these components.

• UNIPAC® DRIVE

Your UNIPAC® drive system is a precision assembly lubricated for long service. Do not attempt to open and service the assembly, which could void your warranty. Contact your authorized service center if problems occur, or call 1-800-248-9131 to speak to a manufacturer service representative.

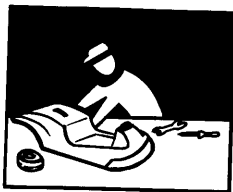

Service

You will get years of dependable service if you follow the suggested maintenance schedule. If you experience a problem and have to write in or call an authorized service center, be sure to provide your serial number. You will find it on the platform where the handle connects to the fork. Model numbers and serial numbers will help us provide efficient service. Call your local Amigo Mobility Center®, Amigo representative, or call: 1-800-248-9131.

Warranties

AMIGO MOBILITY INTERNATIONAL, INC.

July 1, 1994

**AMIGO J9 WORLDWIDE LIMITED
THREE-YEAR WARRANTY**

Amigo Mobility International (AMI), warrants products it manufactures to the original purchaser.

AMIGO J9 MANUFACTURED PRODUCTS

1. The J9 platform is warranted against defects in materials and workmanship for the **LIFETIME** of the product.
2. Structural components that are warranted against defects in materials and workmanship for three (3) years are limited to the following components:
Fork, lower seat post
and upper seat post.
3. UNIPAC®, vari-speed boards, chargers and motors are warranted against defects in materials and workmanship for three (3) years with replacement on a prorated basis.
4. Components warranted for six (6) months against defects in materials and workmanship are limited to the following:
LED lights, electrical and mechanical switches, and batteries provided through AMI.

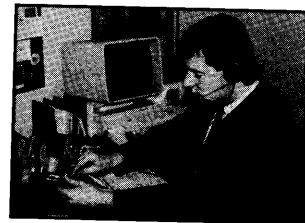

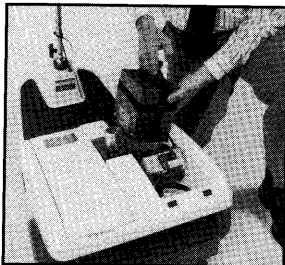

5. Seats and other components have a one-(1) year warranty and are covered against defects in materials and workmanship for one year from date of purchase.
6. Use of this product by persons exceeding 175 lbs. is not recommended. Use of this product by persons exceeding 250 lbs. voids this warranty.
7. After six (6) months, labor will be charged on warranty repairs, except where law prohibits.
8. Items replaced under warranty are covered by the original warranty. Replacement of defective parts does not extend the warranty period.

AMI's obligation under this warranty is limited to replacing or repairing at its option, such products or parts that are returned prepaid by the purchaser and are found to be defective.

If the purchaser elects not to return the product to the factory and wishes a factory service representative to make adjustments and repairs at the product's location, field service rates will apply.

This warranty does not cover accidental damage, misuse, normal wear and tear, or use of Amigo products for other than personal purposes.

If upon inspection, a warranty return is found to be fully functional or failure was due to abuse or wear, the customer will be invoiced for the replacement part. Opening sealed components may void warranty.

The three-year warranty prorating is as follows: (Customer pays)

01 - 12 months =	0
13 - 24 months =	50%
25 - 36 months =	75%

The above warranty supersedes and is in lieu of all other warranties, expressed or implied, and no person, agent or dealer is authorized to give any warranties on behalf of the Manufacturer, nor to assume for the Manufacturer any other liability in connection with any of its products unless made in writing and signed by an official of the Manufacturer.

This warranty provides you with specific legal rights, with the possibility of other rights, which vary depending upon your locality.

A three-year warranty is applicable outside the United States, with the exception of batteries, LED lights, and switches, which have a six-month warranty.

• **SMALL PARTS ORDERS**

Amigo is committed to serving you quickly and efficiently. Yet, in today's economy, it can be expensive at times. The cost of ordering, preparing, packing, invoicing and shipping a part which cost \$1.00 to purchase, costs approximately \$7.00 to send out to you. This cost insures we have accurate records of parts ordered on your Amigo and gives you the added security of warranty coverage. We ask that you help us continue to serve you effectively and help keep the cost of our parts down. On parts orders less than \$7.00, please think about ordering an additional part or kit you've been wanting. This way, you save future shipping costs and we decrease any undue cost to you in the future. Thank you for owning an Amigo.



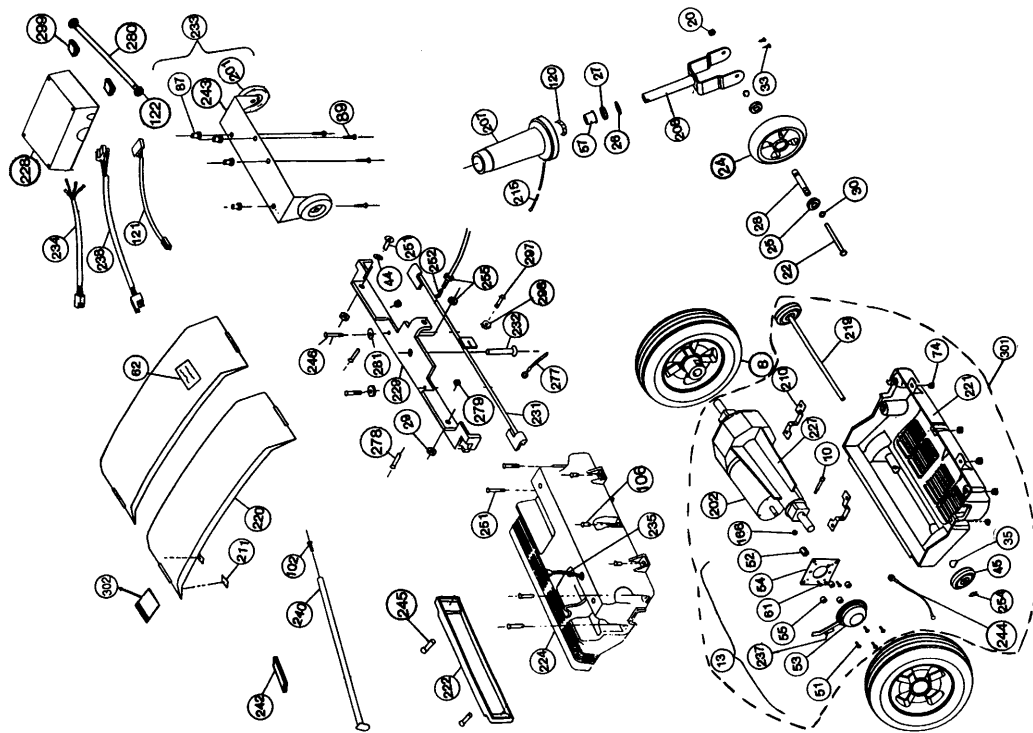

Exploded View

Amigo J9 Parts List

Ref. #	Item #	Description
8	300371	Wheel, 8" Rear w/Insert (Includes #s 10, 166)
10	5865	Screw, 10-24 x 1/4 x 1.25 Shoulder
13	7390	Manual Release E/M Brake Assy. (Includes #s 51-55, 61, 237)
17	7281	Screw - 1/4-20 x .875 SHCS
20	2237	Nut, 3/8-24 Hex
22	6505	Bolt, 3/8-24 x 4.5 Hex HD
24	7309	Wheel Assembly (Includes #s 25, 28, 30)
25	1055	Bearing
26	5413	Washer, Dust Cover
27	5407	Ball Bearing Steering Column
28	6435	Centering Tube, RWD
29	3083	Nut, 1/4-20 Hex Serrated
30	1040	Retaining Ring, Centering Tube
31	7279	Knob, Adjustable Handle
33	1341	Screw, 1/4-20 x .38 Button HD
34	7419	Grip, Adjustable Handle Vinyl MPC
35	5340	Wave Washer
37	5719	Covers, Pair of Adjustable Handle Tab
39	5893	Washer, Fender
43	1391	Screw, 1/4-20 x .5 Button HD
44	1192	Washer, Flat
45	5194	Wheel, 3-inch Stability
46	7441	Circuit Breaker, 25A
47	5200	Terminal Contact
49	7145	Seal, E/M Brake
51	7069	Screw, 10-32 x .875 Socket HD Cap
52	6886	Hub, Manual Release E/M Brake
53	6885	Brake, E/M Brake
54	5811	Plate, RWD E/M Brake Adaptor
55	5832	Spacer, RWD E/M Brake
57	1025	Bearing, Shoulder
58	8261	Collar Kit, Retaining
59	7401	Spacer, Seat
60	8187	Charger, J9 24V
61	6223	Screw, 10-24 x .5 Self-Tapping
62	5806	Label, Warning
64	7272	Articulating Clamp, Threaded
69	7202	Grommet
74	1167	Nut, 1/4-20 Hex Keps
76	5204	Contact, Power Cell
78	5198	Battery, RWD
79	5202	Harness, Battery Lifting
81	100710	Bearing, Lower w/Pin
82	267000	Seat Lock Assy. - RH
	267500	Seat Lock Assy. - LH
84	267001	Stem Collar Bolt & Nut
85	100690	Stem Collar (Includes #84)
86	100670	Seat Post, Upper
87	7303	Well Nut, 1/4 + 20
89	1180	Screw, 1/4-20 x 1.0 Hex HD
90	300220	Cushion Set - High-Back Black Folding
92	210000	Arms, Solid
93	8109	Seat, High-Back White Folding
100	8197	Decal, J9
101	1479	Screw, 10-32 x .625
102	5184	Retainer, Nylon
103	5673	Clip, Wire
105	7438	Wire Assy., Battery to Circuit Breaker
106	1178	Screw, 1/4-20 x .625 Button HD
107	1264	Nut, Hex Keps #10
120	7351	Contact, Grounding
121	7852	Wire Assy., Charger to MPC

122	7600	Push Nut, .25 Diameter	234	8048	Wire Assembly, Contr. to Motor (Female)
126	8223	Throttle Head Enclosure (MPC Centra 6-94)	235	8058	Wire Assembly, Contr. to Motor (Male)
166	6227	Nut, 1-24 Nylon Ins. Hex	236	8200	Contact, Ground
201	300008	Stability Wheel Assembly	237	7116	E/M Brake Switch
202	300360	Motor Assembly	238	7224	Wire Assy., Battery to MPC
203	7739	Mat, Platform	239	8084	Bumper Assembly
204	7742	Washer Steering Cone	240	8085	Weldment, Battery Hold-down
205	7743	Wave Spring	241	8253	Brake Lever and Cable Assy.
206	7744	Retaining Ring	242	8088	Friction Pad
207	7745	Steering Cone	243	7933	Bracket, J9 Stability
208	7750	Fork, J9	244	8060	Wire Assembly – UNIPAC® Ground
209	7752	Cap, Steering Cone	245	8206	Rivet, Plastic
210	7757	Transaxle Clamp	246	7023	1/4-20 Shoulder Bolt
211	7763	Dual Lock 170	247	8117	Handle, Double-Adjustable (Includes #s 36, 37, 126)
212	7764	Wire Assy., Battery to M.C.	249	8106	Rivet, Plastic
213	7765	Wire Assy., Battery Jumper	251	1539	Screw, 1/4-20 x 1.00 Button HD
214	7766	Bracket, Charger	252	8094	Spring Compression
215	7769	Wire Assy., Strg. Cone to Chrg. Ground	254	1077	Clip, Hairpin
216	7770	Wire Tab	255	1988	Nut, 5/16-24 Hex Jam
217	7771	Dual Lock 400	256	2822	Screw, 1/4-20 x 1.75 Hex HD Cap
218	7772	Cover, Seat Post Cone	257	2713	Washer, .75 O.D. x .50 I.D. x .25 Thick
219	7780	Axle, J9 Stability Wheel	258	7760	AC Charge Cord, J9
220	7783	Battery Cover, J9	259	5905	Screw, 1/4 x 2.25 Hex HD
221	7785	J9 Lower Transaxle Housing	260	8092	Brake Cable Clamp
222	7787	J9 Rear Bumper	277	8123	Ground Strap Assembly
223	8251	J9 Body Assembly	278	8201	Screw, 1/4-20 x .75 Nylon Hex HD
224	7789	J9 Upper Transaxle Housing Assy.	279	6216	Nut, 1/4-20 Nylon
225	7812	Name Plate, J9	280	8199	Rod, Controller Pivot
226	7317	Bumper, Rubber 3M	281	8243	Spacer, .62 OD x .328 ID
227	7918	UNIPAC® 16:1 J9 (Includes #19)	297	3617	Screw, #6-32 x .31 Pan HD
228	7919	Controller, J9	298	6905	Nut, #6-32 Hex
229	8013	Support, J9 Safety Brake	299	2715	Cable, Clip
231	8016	Shaft Lever Assy.	300	1340	Screw, 1/4-20 x .75 Button HD
232	8018	Bolt, Flat Head 3/8-16 x 1.25	301	8255	J9 Compl. Transaxle Assy. w/o Wheels
233	8030	Stability Bracket Wheel Assy.	302	8254	J9 Diagnostic Kit

WIRING DIAGRAM

• J9 •

