

Featuring:  
• **Amigo**  
**FWD**

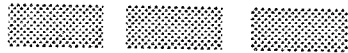

Serial Number:

Date of Purchase:

# AMIGO OWNER'S

# MANUAL



*Front  
Wheel  
Drive*



<b>Welcome and First Things First .....</b>	<b>2, 3</b>
<b>Safety First .....</b>	<b>4</b>
■ Safety Suggestions .....	4,5
<b>Getting Down to Basics .....</b>	<b>6</b>
■ Assembly Instructions .....	7 - 9
Battery Information and Charger Instructions .....	9 - 13
<b>Now It's Your Turn .....</b>	<b>14</b>
■ Operating Your Amigo .....	15 - 17
■ Helpful Hints for Everyday Use .....	18 - 20
<b>Amigo, A Friend for Life .....</b>	<b>21</b>
■ Maintenance .....	22
■ Service .....	23
■ Warranties .....	24 - 26
<b>Amigo FWD (Exploded View Diagrams) .....</b>	<b>28 - 29</b>
(Parts List) .....	30 - 32
<b>Accessories .....</b>	<b>33</b>
<b>Wiring Diagrams .....</b>	<b>34 - 35</b>

# CONTENTS

# T A B L E O F



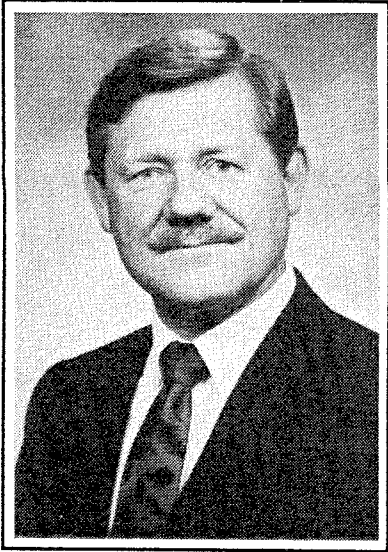

Allan R. Thieme

W  
E  
L  
C  
O  
M  
E  
T  
O  
O  
U  
R  
F  
I  
R  
S  
T  
T  
H  
I  
N  
G  
S  
F  
I  
R  
S  
T

**W**elcome to the Amigo family of active and independent people. For thousands of individuals around the world, the AMIGO provides the opportunity to enjoy life more fully. We are confident that the following instructions and helpful hints will make the Amigo an extremely useful and reliable "friend." Because we are concerned about your health and safety, please read this manual carefully before operating your Amigo. When you learn how to use the Amigo properly, you will discover a world of enjoyment and independence.

As a member of the Amigo family, you will receive the *Friendly Wheels*, our magazine written especially for and about Amigo owners after you return your warranty card. The *Friendly Wheels* will keep you informed about new products and accessories, helpful hints and service tips!

Please write us and include a photograph of yourself and your Amigo. Your letters are a source of inspiration to us. As you use your Amigo, be sure to share your helpful hints and operating suggestions with us so we can pass them on to other owners.

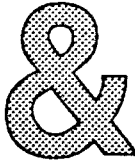

Wishing you happiness and good health from all of us at Amigo Company.

Sincerely,  
**Allan R. Thieme**  
*President & Founder*

**FIRST  
THINGS FIRST**

- CHECK YOUR ORDER
- COMPLETE AND RETURN WARRANTY CARD
- DO NOT OPERATE YOUR AMIGO UNTIL YOU HAVE COMPLETELY READ THIS OWNER'S MANUAL
- REPAIR HOTLINE 1-800-248-9131

*For your convenience and understanding, signal words are defined below:*

**⚠ DANGER**

*Danger is used to indicate the presence of a hazard which will cause severe personal injury, death, or a substantial property damage if the warning is ignored.*

**⚠ WARNING**

*Warning is used to indicate the presence of a hazard which can cause severe personal injury, death, or substantial property damage if the warning is ignored.*

**⚠ CAUTION**

*Caution is used to indicate the presence of a hazard which will or can cause minor personal injury or property damage if the warning is ignored.*



*NOTICE: This book pertains to FWD Amigo models. Do not operate your Amigo until you have completely read this Owner's Manual.*

**⚠ CAUTION**

*Your Amigo may tip under certain conditions such as: a sharp turn at high speed or picking up something from the floor. Be careful to situate yourself in a stable position.*

*Amigo Mobility International, Inc. (AMI) disclaims any responsibility for personal injury or property damage resulting from the improper or unsafe use of its products.*

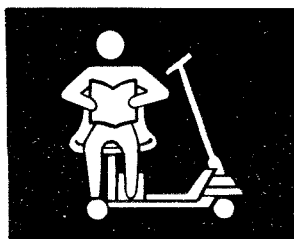

# Safety Suggestions

Use the following rules as guidelines for the safe operation and use of your Amigo. Should you have any questions about the safe operation or use of your Amigo, please contact AMI. If you are in doubt about your ability to operate your Amigo, consult your personal physician.

## PERSONAL SAFETY INSTRUCTIONS

- *Keep legs on the platform while driving the Amigo.*
- *Drive slowly while turning and on inclines.*
- *Drive straight up and down inclines.*
- *Do not park on inclines or declines.*
- *Your Amigo is restricted to one occupant.*
- *Occupant must remain seated while operating Amigo.*
- *Lock seat in forward position before operating Amigo.*
- *Maximum load capacity is 250 pounds (112.5 kg).*
- *Armrests and handlebar must be in riding position while operating your Amigo.*

**Y  
F  
E  
E  
A  
S**

**FIRST**

- Make sure the battery is secured in place.
- Use dual wheels for added stability.
- Do not drive over or off obstacles more than 1 inch (2.54 cm) high. This could be unsafe and could damage your Amigo.
- Do not make sharp, abrupt turns at high speeds or going down an incline.
- Avoid sudden starts while the handlebar is turned sharply.
- Avoid inclines or ramps having a rise of more than 1 inch (2.54 cm) per foot (meter) (federal standard for wheelchair ramps).
- Do not operate on streets or other areas with vehicular traffic.
- When driving over bumps, dips or inclines, approach them at a 90-degree angle.
- Do not back onto any changes in the surface or grade.
- Do not back down inclines.
- Do not sit on the Amigo in a moving vehicle unless it is secured by an approved restraint system.
- When operating under low light conditions, equip the Amigo with proper lighting.
- Operate your Amigo only when the power seat lift is in its lowest position.
- If you have a two-speed handle, always place thumb control lever at a 90-degree angle to handle and apply parking brake when stopped or transferring.
- Travel over grass, gravel, or soft dirt is not recommended.
- When transferring off your Amigo, make sure the seat lock is in the locked position.
- To transport the Amigo with an adjustable handle, **DO NOT** remove handle from steering column. Instead, loosen the knob near the bottom of the handle so you can fold the handle down to the base. Place the handle down so that the HI/LO knob will not become damaged. Tighten the knob to secure the handle.
- When utilizing public transportation, do not sit on your Amigo while it is being lifted onto the vehicle. Where this is not possible, a proper hold-down system should be provided.
- Dual wheels are required for use outdoors and on rough or uneven surfaces.

### **CAUTION**

*Turning the key "OFF" while in motion will bring the Amigo to an abrupt stop.*

### **CAUTION**

*Do not use a garden hose to clean your tires. Water may get into the controller and cause electronic malfunctions.*

### **Safety:**

We do not suggest using the Amigo with elevated van lifts.



# GENIE

- **ASSEMBLY INSTRUCTIONS**
  - Handle
  - Seat Installation
  - Seat Positioning
  - Dual Wheels
- **BATTERY INFORMATION AND CHARGER INSTRUCTIONS**
  - Battery Maintenance
  - General Maintenance
  - Gel Cell Batteries
  - Quick Battery Recharging Instructions
  - Battery Charger Troubleshooting
- **CIRCUIT BREAKER AND FUSE REPLACEMENT INSTRUCTIONS**

# DOWN TO BASICS

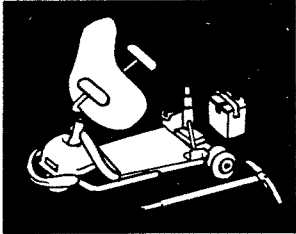

# Assembly Instructions

---

---

## • HANDLE ADJUSTMENT

### “T” Handle - Two Speed

Insert the drive handle into the opening in the steering column and place the thumb control level at a 90-degree angle to the handle.

To adjust the angle of the handle, loosen the lower knob to separate the meshed teeth. Move the handle into the desired position and tighten the knob (Figure 1).

## • SEAT INSTALLATION

1. Unlock the seat lock.
2. Insert the upper seat post into the opening of the lower seat post.
3. Spin seat around to make sure it rotates freely.

4. To lock the seat, pull the seat lock lever toward the rear of the seat.

### Without Power Seat Lift

To raise or lower your seat height, remove the nut and screw that hold the seat collar in place on the seat post, then adjust and reinstall in one of the holes on the seat post.

### **CAUTION**

*It is recommended that the seat lock be installed in the second hole positioned from the seat on a folding seat and the third hole on a fiberglass seat. If you desire to put your seat higher than this, you must have dual wheels on your Amigo.*

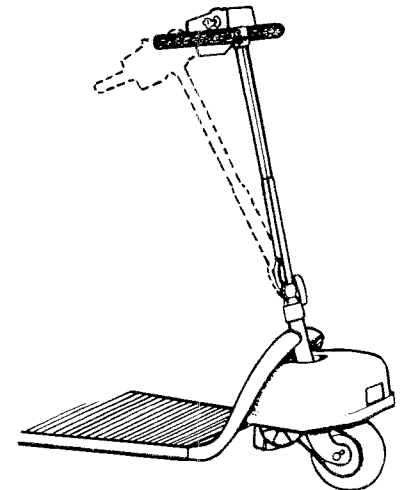

Figure 1



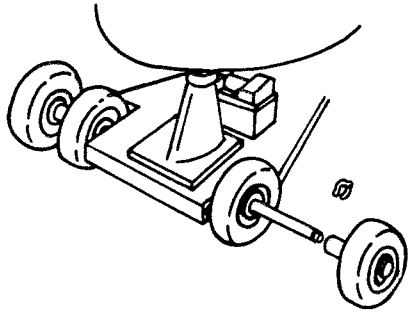

Figure 2

### With Power Seat Lift

To change the location of your power seat lift switch bracket to a more convenient side follow these steps:

1. Loosen the holding set screws on the switch bracket using a 1/8" (3 mm) allen wrench.
2. Lower the seat lift to *the lowest position*.
3. Rotate switch bracket around the seat post until the most convenient position is located.
4. Tighten the holding set screws securely on the switch bracket.
5. Check the clearance between the seat lock casting and switch bracket. Make sure there is no interference between the seat lock casting and switch bracket when the seat is swiveled.

### • DUAL WHEELS

On the Amigo FWD, dual wheels provide additional stability and are required for use on rough or uneven surfaces and outdoors.

Parts list:

- (3) Dual wheel clips (two are extra)
  - (3) "E" rings can be used in place of wheel clips.  
- "E" rings are more difficult to put on, but hold better than clips.
  - (1) Dual wheel rod
  - (2) Dual wheels
- No tools needed.

Installation (See Figure 2)

1. Put one dual wheel on the axle rod.
2. Slide it all the way over to the permanently installed "E" ring. When placing wheel on rod, the side with extended spacer should be facing inward.
3. Slide dual wheel rod all the way through the axle opening in platform.
4. Put dual wheel on other side with extended spacer facing inward.
5. Secure wheel with dual wheel clip, making sure it is completely in the groove.

### **⚠ CAUTION**

*If you are installing dual wheels on an Amigo you've had for some time, test the*

*braking action after the dual wheels have been installed. To do this, engage the brake lock and press the thumb control lever to see if the Amigo stays in place.*

If the inside wheels are slightly worn, the dual wheels may lift them off the ground to the point where the brake lock will not lock the Amigo. Should this happen, reverse the two wheels, putting the new wheels to the inside and the original wheels on the outside of the rod. Always test the braking action before transferring from your Amigo.

#### *Removing Dual Wheels:*

It's best to leave them on for extra stability, but if dual wheels must be removed for narrow spaces, here's how:

1. Remove dual wheel clip from end of rod.
2. Remove wheel.
3. Pull rod and other wheel completely out of axle opening.
4. Replace wheels and clips on rod for storage.

## • **BATTERY INFORMATION AND CHARGER INSTRUCTIONS**

### *12-volt charger*

It is a popular misconception that batteries should be deeply discharged before recharging. This is not the proper procedure for batteries. They can actually be damaged if they are discharged too deeply before recharging.

Recharge your batteries daily when the Amigo is used. This will allow the maximum power and range capability. Batteries should not be left in a discharged state, or their life expectancy will be shortened.

### Operating Instructions

1. Turn your Amigo "OFF."
2. Connect the charger cord to the charger plug on the battery. Plug charger into electrical outlet. Your charger should now be charging your battery. The indicator light confirms this.



## Universal Charger Option

*A Universal Charger is available on many Amigos sold outside the United States. The Universal Charger uses a range of 90 - 240 volts AC power input. This makes it possible to charge on any electrical system globally. (The Universal Charger is an option on models in the US for people who travel abroad and want this universal charging flexibility.)*

*Your charger is labeled identifying which charging system it uses.*

*Do not use a 12-volt charger that is configured to a 120-volt AC power input outside the US in countries using 220-volt AC power input. Damage will occur to the charger.*

3. When charging is complete, disconnect AC cord from electrical outlet, then disconnect charger cord from battery.

### LED Monitor Displays

**Continuous red:** Proper connection.

**Continuous green:** Battery 90% charged.

**Blinking Green:** Battery is fully charged.

### Level of Charge in the Battery:

The LED light will dim as the battery charge is used up. The most accurate measure of charge is obtained by looking at the LED while operating your Amigo for at least 10 feet (3.05 meters). If the light is very dim or out, recharge at your earliest convenience. Looking at the light when the Amigo is not moving or when it has just started moving will not give an accurate reading.

**NOTE:** Make sure that the wall cord is unplugged from the wall outlet before disconnecting or moving your Amigo.

### Troubleshooting Guide

1. *No red light when charger is connected to battery and the electrical outlet. Check that the cord is plugged in properly and that the outlet works by plugging in an appliance. If power is being supplied to charger then return the charger for service.*
2. *If green LED does not come on within 12 hours and charger is warm, something is wrong with the battery; have it checked.*
3. *If green LED comes on but does not flash after six hours, return the charger for service.*
4. *If the green LED does not turn on immediately after the charger is removed from the battery while still plugged into outlet, return the charger for service.*

## Charger Storage

- Always store in dry place.
- Coil up cords when not in use.
- Clean case and cords with slightly damp cloth to keep free of acid, grease and dirt.
- Clean any corrosion from plug.
- Examine cords periodically for cracking or damage.

### **⚠ CAUTION**

*Failure to follow these safety instructions may result in personal injury or property damage.*

- A. Save these instructions.
- B. Each time you use your charger read and follow instructions exactly. Working in the vicinity of a gel cell battery is dangerous. Batteries generate explosive gases during normal battery operation.
- C. Never smoke or allow an open flame in the vicinity of the battery.
- D. Use charger for charging a lead-acid, gel cell battery only. It is not intended to supply power to an extra-low-

voltage electrical system or to charge dry-cell batteries.

- E. Never charge a frozen battery.
- F. Never place the charger directly above or below the battery being charged. Locate the charger as far away from the battery as the charging cord permits.
- G. Do not operate charger in a closed-in area or restrict ventilation in any way.
- H. Disconnect DC output charger cord only after removing AC cord from electrical outlet.
- I. A spark near battery may cause explosion. To reduce risk of spark:
  - 1) Prevent external damage to AC and DC cords.
  - 2) Connect DC charging cord to the battery charge plug.
  - 3) Connect charger AC supply cord to electrical outlet.
  - 4) When disconnecting charger, always do so in reverse sequence of connecting procedure. Break first connection as far away from battery as practical.
- J. Someone should be within range of



your voice or close enough to come to your aid.

- K. Be extra cautious not to drop metal tool onto battery(s).
- L. Remove jewelry.

*Battery Maintenance:*

*See page 22 in the Maintenance Section.*

### **⚠ CAUTION**

*Make sure that the wall cord is unplugged from the wall outlet before moving your Amigo.*

## • **CIRCUIT BREAKER**

A circuit breaker protects the wiring and battery in the event of a short circuit. If your Amigo stops, check for overloads or short circuits before continuing to operate.

Circuit breaker is located inside battery top and attached to positive terminal. Using a screwdriver with an insulated handle, lightly place the tip of the screwdriver between the screws of the circuit breaker on the positive terminal. If a large continuous spark oc-

curs, call a service representative. When the LED light brightens or battery gauge goes up, the circuit breaker is functional.

*NOTE: Charge your battery(s) every day you use your Amigo (even if it is only for a short time).*



# Electromagnetic Interference

## Attachment A

### **WARNING: Radio wave sources may affect powered wheelchair control**

Radio wave sources, such as radio stations, TV stations, amateur radio (HAM) transmitters, two-way radios, and cellular phones, can affect powered wheelchairs and motorized scooters (in this text, both will be called powered wheelchairs). Following the warnings listed below should reduce the chance of unintended brake release or powered wheelchair movement which could result in serious injury.

- 1) Do not turn ON hand-held personal communication devices, such as citizens band (CB) radios and cellular phones, while the powered wheelchair is turned ON;
- 2) Be aware of nearby transmitters, such as radio or TV stations, and try to avoid coming close to them;
- 3) If unintended movement or brake release occurs, turn the powered wheelchair OFF as soon as it is safe;
- 4) Be aware that adding accessories or components, or modifying the powered wheelchair, may make it more susceptible to interference from radio wave sources (Note: There is no easy way to evaluate their effect on the overall immunity of the powered wheelchair); and
- 5) Report all incidents of unintended movement or brake release to the manufacturer, and note whether there is a radio wave source nearby.

### **Important Information**

- 1) 20 volts per meter (V/m) is a generally achievable and useful immunity level against interference from radio wave sources (as of May 1994) (the higher the level, the greater the protection);
- 2) The immunity level of this product is not known.

**CAUTION: It is very important that you read this information regarding the possible effects of electromagnetic interference on your powered wheelchair.**

### **Electromagnetic Interference (EMI) From Radio Wave Sources**

Powered wheelchairs and motorized scooters (in this text, both will be referred to as powered wheelchairs) may be susceptible to electromagnetic interference (EMI), which is interfering electromagnetic energy (EM) emitted from sources such as radio stations, TV stations, amateur radio (HAM) transmitters, two-way radios, and cellular phones. The interference (from radio wave sources) can cause the powered wheelchair to release its brakes, move by itself, or move in unintended directions. It can also permanently damage the powered wheelchair's control system. The intensity of the interfering EM energy can be measured in volts per meter (V/m). Each powered wheelchair can resist EMI up to a certain intensity. This is called its "immunity level." The higher the immunity level, the greater the protection. At this time, current technology is capable of achieving at least a 20 V/m immunity level, which would provide useful protection from the more common sources of radiated EMI. The immunity level of this powered wheelchair model is not known.

There are a number of sources of relatively intense electromagnetic fields in the everyday environment. Some of these sources are obvious and easy to avoid. Others are not apparent and exposure is unavoidable. However, we believe that by following the warnings listed below, your risk to EMI will be minimized.

The sources of radiated EMI can be broadly classified into three types:

- 1) Hand-held portable transceivers (transmitters-receivers) with antenna mounted directly on the transmitting unit. Examples include: citizens band (CB) radios, "walkie talkie," security, fire, and police transceivers, cellular telephones, and other personal communication devices. Note: Some cellular telephones and similar devices transmit signals while they are ON, even when not being used;
- 2) Medium-range mobile transceivers, such as those used in police cars, fire trucks, ambulances, and taxis. These usually have the antenna mounted on the outside of the vehicle; and
- 3) Long-range transmitters and transceivers, such as commercial broadcast transmitters (radio and TV broadcast antenna towers) and amateur (HAM) radios. Note: Other types of hand-held devices, such as cordless phones, laptop computers, AM/FM radios, TV sets, CD players, and cassette players, and small appliances, such as electric shavers and hair dryers, so far as we know, are not likely to cause EMI problems to your powered wheelchair.

### **Powered Wheelchair Electromagnetic Interference (EMI)**

Because EM energy rapidly becomes more intense as one moves closer to the transmitting antenna (source), the EM fields from hand-held radio wave sources (transceivers) are of special concern. It is possible to unintentionally bring high levels of EM energy very close to the powered wheelchair's control system while using these devices. This can affect powered wheelchair movement and braking. Therefore, the warnings listed below are recommended to prevent possible interference with the control system of the powered wheelchair.

### **Warnings**

Electromagnetic interference (EMI) from sources such as radio and TV stations, amateur radio (HAM) transmitters, two-way radios, and cellular phones can affect powered wheelchairs and motorized scooters. Following the warnings listed below should reduce the chance of unintended brake release or powered wheelchair movement which could result in serious injury.

- 1) Do not operate hand-held transceivers (transmitters-receivers), such as citizens band (CB) radios, or turn ON personal communication devices, such as cellular phones, while the powered wheelchair is turned ON;
- 2) Be aware of nearby transmitters, such as radio or TV stations, and try to avoid coming close to them;
- 3) If unintended movement or brake release occurs, turn the powered wheelchair OFF as soon as it is safe;
- 4) Be aware that adding accessories or components, or modifying the powered wheelchair, may make it more susceptible to EMI (Note: There is no easy way to evaluate their effect on the overall immunity of the powered wheelchair); and
- 5) Report all incidents of unintended movement or brake release to the powered wheelchair manufacturer, and note whether there is a source of EMI nearby.

### **Important Information**

- 1) 20 volts per meter (V/m) is a generally achievable and useful immunity level against EMI (as of May 1994) (the higher the level, the greater the protection);
- 2) The immunity level of this product is not known.



MON

## ■ OPERATING YOUR AMIGO

- Handle Adjustments
- Driving Your Amigo
- Manual Pushing
- Power Seat Lift Operation - Optional
- Power Seat Lift Maintenance
- Optional Equipment
- Transporting Your Amigo
- Airplane Travel
- Ground Travel

## ■ HELPFUL HINTS FOR EVERY DAY USE

- Bathroom
- Bedroom
- Kitchen
- Car
- Inclines and Ramps
- Using An Elevator
- Opening Doors
- Keep Your Amigo Shining
- Speed Controls
- Stopping
- Instructions to Baggage Handlers

# IT'S YOUR TURN



# Operating Your Amigo

## • HANDLE CONTROLS

To adjust the position of your handle, see the “Handle Adjustment” section (page 7)

### TWO-SPEED FWD:

When not using the Amigo, place the thumb control at a 90-degree angle to handle (Figure 3). This turns the Amigo “OFF” and is a safety feature.

*NOTE: If you have a two-speed (not variable), you can use the SPRING COIL which is included in your owner’s package.*

By placing this spring under the thumb control, the dynamic brake will be in effect as soon as you let go of the the thumb control. Without this spring, lift the thumb control for dynamic braking.

### VARI-SPEED FWD

Handle controls include: Top speed setting dial, key extension and battery indicator light (Figure 4).

The key extension (Figure 7), located on the right side of the handle control box, will turn the power of the Amigo “ON” or “OFF.” Turning it “OFF” will prevent drainage of batteries and unauthorized use. The top speed may be adjusted by turning the speed knob (a maximum of 3.5 mph/5.64 kph)(Figure 6).

## • DRIVING YOUR AMIGO

To move forward, pull the right side of the hand control lever toward you (Figure 5). You can also move forward by pushing the left side of the control lever away from you. By releasing the control lever, you will come to a

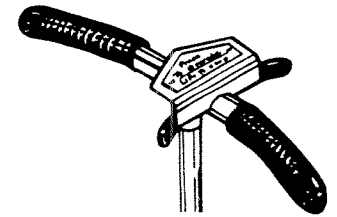

Figure 3

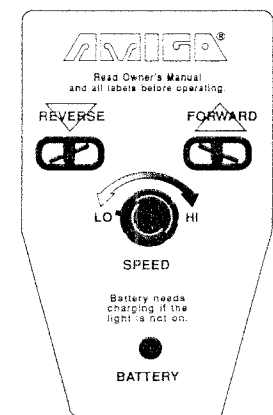

Figure 4



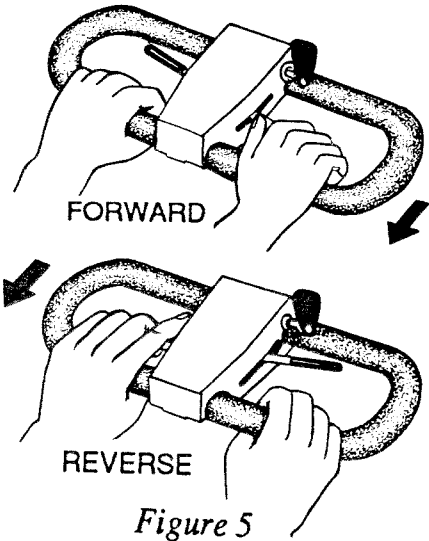

Figure 5

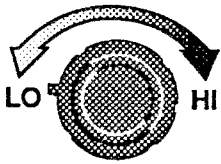

Figure 6

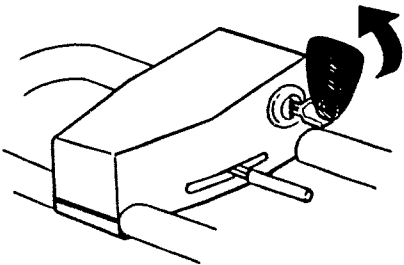

Figure 7

stop approximately one second after release. To operate in reverse, pull the left side of the hand control lever toward you, or push the right side control lever away from you. Your Amigo is equipped with a hand-operated brake lock which will keep the Amigo from rolling when stopped. It also can be used as an emergency brake. *Note: Do not operate your Amigo with the brake lock on.*

### • MANUAL PUSHING

In case of power failure, when it is necessary to push by hand, remove the belt in the drive head to make it roll easier.

### • POWER SEAT LIFT OPERATION - (Optional)

The power seat lift switch is below your seat. This switch allows lifting or lowering the seat from 17 inches to 21 inches (43.18 cm to 53.34 cm) from the ground. The seat can be stopped in any position to facilitate transferring. The seat must be in its lowest position when your Amigo is in motion.

*Note: Your power seat lift must be in the lowest position before tightening the set screws on the switch bracket. Failure to do so may cause damage to your seat lift.*

### • POWER SEAT LIFT MAINTENANCE

Approximately every one or two months, remove the seat and activate seat lift to the highest position. Using a dry cloth, wipe inner tube of accumulated grease and dirt. Then, apply a very thin coating of grease to inner tube, except for one inch (2.54 cm) on top of tube.

*NOTE: A tube of grease has been supplied. White Lithium grease is recommended and can be purchased at your local hardware store.*

### • MANUALLY TRANSPORTING YOUR AMIGO

Your Amigo can be disassembled and transported in most car trunks (Figure 8).

1. Turn your Amigo "OFF."
2. Unlock the seat and remove it completely.
3. Remove the battery.
4. Fold handle down to the platform (See page 7) if you have a vari-speed drive head. Remove the handle if you have a two-speed.
5. Lift the rear into the trunk of the vehicle and slide the Amigo into the trunk.
6. Place seat and battery in the trunk.
7. If your Amigo has a power seat lift, we suggest placing a cut out tennis ball or something similar over the seat post to protect it. If you leave the battery connected, make sure the lift cannot be accidentally activated.

**• LOAD YOUR AMIGO INTO YOUR CAR WITH A LIFT•ALL®**

*NOTE: For greater convenience, purchase a Lift•All® to assist you when loading and unloading. For more information on the*

*Lift•All®*, contact your local Amigo Mobility Center® or call toll-free: 1-800-248-9131. For your safety, use hold-down systems to secure your Amigo during transport. We do not recommend using the Amigo with elevated van lifts.

**• AIRPLANE TRAVEL**

An Airline Travel Kit (Item #300116) is available from Amigo Mobility International, Inc. It contains a battery holding strap, three "Special Handling" tags and a "Helpful Hints for Airline Travel" booklet. Non-spillable gel-cell batteries are approved for travel on airplanes. When you make your reservation, notify the airline that you will be requesting an "Escort" service. This will assure you that your Amigo will be picked up and delivered at the boarding gate.

**• GROUND TRAVEL**

Some public transportation systems have accommodations for your Amigo. You must transfer to a seat if the transit system is not equipped with an approved restraint system.

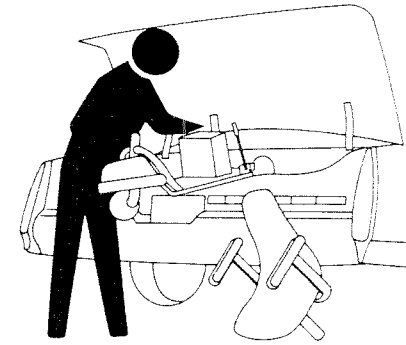

*Figure 8*

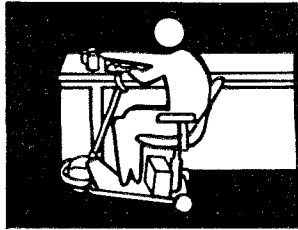

# Helpful Hints for Everyday Use

---

---

## • BATHROOM

In the bathroom, maneuvering room is usually limited. Position close to the toilet, swivel the seat, lock it in position and transfer.

When using the bathtub, back up parallel to the tub. Swivel the seat and place your feet in the tub. Engage seat lock and carefully transfer.

### **⚠ WARNING**

*Do not use your Amigo while taking a shower. The water may get into the controller and cause electronic malfunctions.*

## • BEDROOM

To transfer to the bed, back up parallel to the bed. Swivel, lock seat into position, and

ease onto the bed. If charging the batteries overnight, it may be easiest to plug in the battery charger before transferring. For added ease, when using your power seat lift, raise your seat slightly higher than the surface from which you are transferring.

## • KITCHEN

For access to a refrigerator, make a parallel approach or back up to the outside of the refrigerator. Swivel the seat.

Approach a table, sink, or stove by maneuvering parallel to it. Swivel the seat to the desired position. The handle will be out of the way.

## • CAR

To transfer to a car, make a parallel

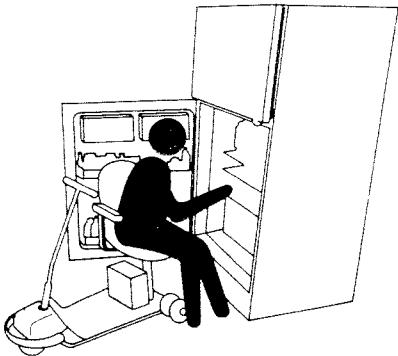

approach to the side of the car, release the door latch, and open the door as you drive forward. Back parallel to the side of the car and into the door opening. Swivel the seat and lock it in position and carefully slide onto the car seat. On the driver's side you can use the steering wheel for leverage.

## • RAMPS AND INCLINES

- Always lean forward as you maneuver your Amigo up a ramp or incline of an angle equal to 1 inch (2.54 cm) of rise to 12 inches (30.48 cm) of travel length.
- Engage your seat lock when travelling up ramps or inclines.

## • USING AN ELEVATOR

Backing into an elevator allows you to exit forward. Be sure the elevator is level with the floor.

## • OPENING DOORS

When a door opens toward you, approach at an angle and just off to one side. Grasp the door knob, reverse and pull the door open. For doors that open away from you, position

the bumper against the door, close to the doorjamb on the doorknob side of the door. After you release the latch, use the bumper to push the door open.

### **⚠ CAUTION**

*BE CAREFUL WITH GLASS DOORS TO AVOID PERSONAL INJURY!*

## • KEEP YOUR AMIGO SHINING

Clean a fabric seat with upholstery cleaner or wash with mild soap and water. Wipe the naugahyde seat clean with a damp cloth. Protect the housings and all painted parts with a coat of auto wax.

### **⚠ CAUTION**

*Do not use a garden hose to clean your tires. Water may get into the controller and cause electronic malfunctions.*

## • SPEED CONTROLS

Slower speeds are recommended indoors and while learning to operate your Amigo. Higher speeds can be used when conditions allow.

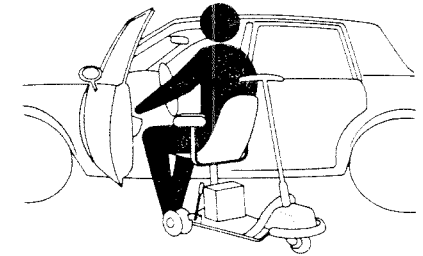



## • STOPPING

1. Dynamic braking will gradually bring your Amigo to a stop on a level surface.
2. IN EMERGENCY ONLY - quick stopping with your Amigo can be accomplished by reversing the handle control in order to reverse the direction the Amigo is travelling.

**⚠ CAUTION**

**THIS PROCEDURE IS  
NOT RECOMMENDED.**

## • INSTRUCTIONS TO BAGGAGE HANDLERS

1. Make an instruction tag and attach it to your PMA (platform mobility aid) in a conspicuous place.

2. List the following instructions:

### **TO ROLL:**

Holding onto handle and armrest, tilt so one rear wheel is not touching the ground.

### **TO CARRY:**

Lift by rear of the platform. If a basket is attached, use the sides of the bumper. Do not lift by seat, arms, or plastic housing.

### **BATTERIES:**

Located directly below the seat in plastic battery box. Disconnect by loosening the two star-shaped knobs on top of the battery box and remove wire and retighten knobs. Strap batteries in place.

Amigo owners say that the best way to insure proper handling is to deliver your PMA. personally to the handler and explain face-to-face the instructions and add the ever-powerful statement, "This is my legs."

■ **MAINTENANCE**

- Daily
- Monthly
- Yearly
- Controller

■ **SERVICE**

■ **WARRANTIES**

**A FRIEND  
FOR LIFE**

**AMIGO**

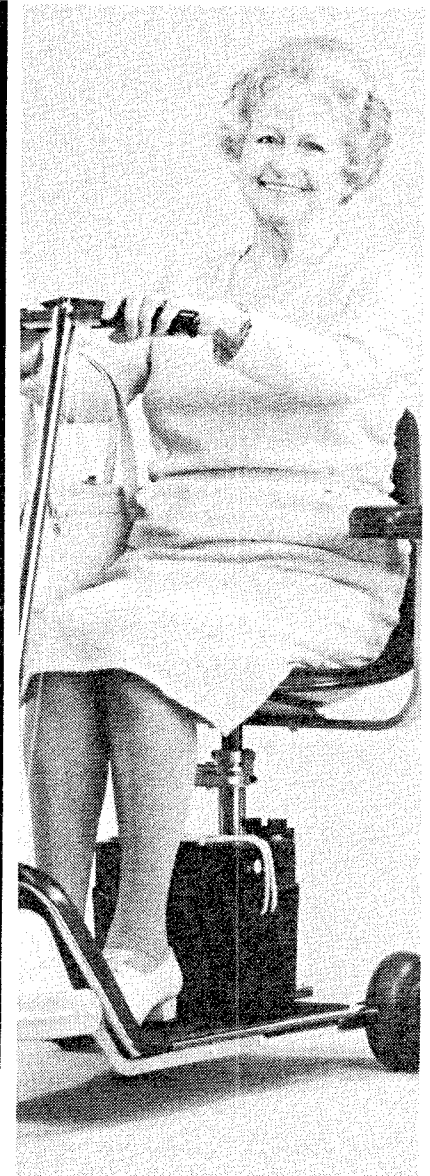

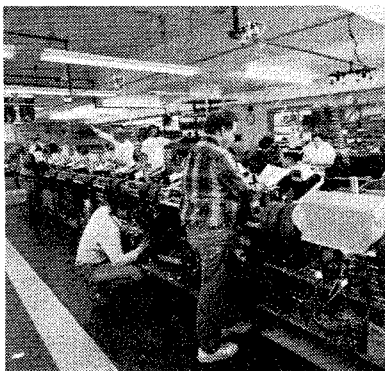

# Maintenance

---

---

Minimum maintenance is required to increase your service ease and dependability. Check the following:

- **DAILY**

- Maintain battery charge.

- **IF YOU USE YOUR AMIGO DAILY**

- It is important to charge the battery daily. Charge the battery until fully charged to ensure battery operation throughout the cold weather months.

*Storage Tip: Extended charging is good for the battery. The battery will not overcharge. Charge the battery fully and store indoors in an arid environment. Do not store on concrete since this will continue to draw on the battery. Protect your battery by placing it on a wood block instead.*

- **MONTHLY**

- Clean upholstery, plastic and metal with

a mild surface cleaner.

- Check and tighten any exposed fasteners.
- Check front wheel bearings for roughness during rotation. Replace if necessary.
- Make sure all fasteners are tight at all connections on battery box.

- **YEARLY**

- Have your authorized service center check your Amigo completely.

- **CONTROLLER**

Do not attempt to service the controller or related electronic components as you may void your warranty. Do not open these components.

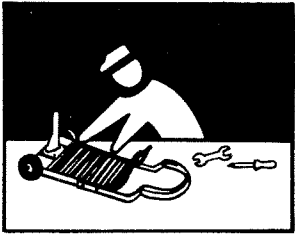

## Service

You will get years of dependable service if you follow the suggested maintenance schedule. If you experience a problem and have to write in or call an authorized service center, be sure to provide your serial number. You will find it on the left side of the drive head frame and on the nameplate. Model numbers and serial numbers will help us in providing efficient service. Call your local Amigo Mobility Center®, Amigo representative, or 1-800-248-9131.

### • BELT ADJUSTMENT

1. Remove the seat, handle and battery.
2. Tip the Amigo up and let it rest on the lower seat post.
3. Loosen the two screws at the terminal block and detach head wires.
4. Remove retaining screw and collar and then the drive head.

### **⚠ CAUTION**

*Examine the steering bushings before removing for reinstallation. If the drive head has a lot of play or is wobbly, the bushings may need to be replaced.*

5. Loosen nuts holding motor in place just enough to allow movement of motor. Using a big screwdriver, pry motor away from head frame until belt has 1/4-inch (.64 cm) deflection in tightest position.
6. To reinstall drive head, reverse directions.

### • CHAIN ADJUSTMENT

1. Loosen axle nut enough that a tap is required to move wheel assembly.
2. Tap axle forward until there is approxi-

*When replacing fasteners, use only Grade 8 (U.S.) or 12.9 DIN (metric) in all applications.*

*For service and replacement parts, we recommend using Amigo authorized parts.*

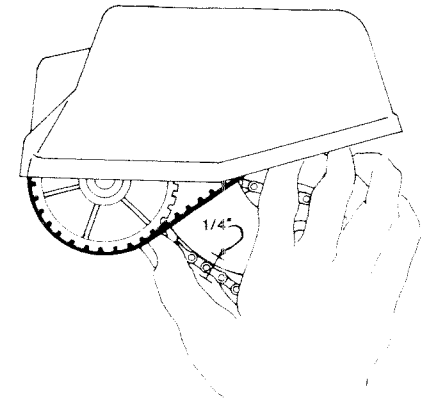



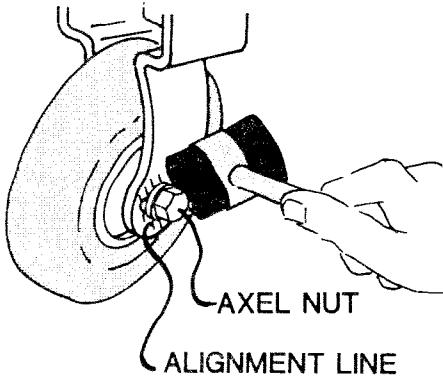

- mately 1/4-inch (.64 cm) slack in the chain. Do not tighten the chain completely.
3. Check that the axle is square in the frame. Alignment is very important.
  4. Tighten axle nut securely and recheck alignment.
  5. Lubricate chain for quieter and smoother operation.

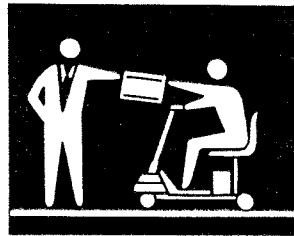

## Warranties

---

---

AMIGO MOBILITY INTERNATIONAL, INC.

Effective January 1, 1994

### • **WORLDWIDE LIMITED THREE-YEAR WARRANTY**

Amigo Mobility International, Inc. (AMI), warrants products it manufactures to the original purchaser.

### ALL AMIGO MANUFACTURED PRODUCTS

1. Structural components that are warranted against defects in materials and workmanship for three (3) years are limited to the following components:

Platform, fork, lower seat post and upper seat post.

2. UNIPAC®, Vari-speed boards, chargers

and motors are warranted against defects in materials and workmanship for three (3) years with replacement on a prorated basis.

3. Components warranted for six (6) months against defects in materials and workmanship are limited to the following:

LED lights, electrical and mechanical switches, and batteries provided through AMI.

4. Seats and other components have a one-(1) year warranty and are covered against defects in materials and workmanship for one year from date of purchase.

5. Use of this product by persons exceeding 350 lbs (157.5 kg) on the composite platform, 250 lbs. (112.5 kg) on the aluminum and steel platform, 250 lbs. (112.5 kg) on a power seat lift, and 200 lbs. (90 kg) on the Lift•All® is not recommended and voids this warranty.

6. After six (6) months, labor will be charged on warranty repairs, except where law prohibits.

7. Items replaced under warranty are covered by the original warranty. Replacement of defective parts does not extend the warranty period.

AMI's obligation under this warranty is limited to replacing or repairing at its option, such products or parts that are returned prepaid by the purchaser and are found to be defective.

If the purchaser elects not to return the Amigo to the factory and wishes a factory service representative to make adjustments and repairs at the product's location, field service rates will apply.

This warranty does not cover accidental damage, misuse, normal wear and tear, or use of Amigo products for other than personal purposes.

If upon inspection a warranty return is found to be fully functional or failure was due to abuse or wear, the customer will be invoiced for the replacement part. Opening sealed components may void warranty.

The three-year warranty prorating is as follows: (Customer pays)

01 - 12 months = 0

13 - 24 months = 50%

25 - 36 months = 75%

The above warranty supersedes and is in

***Please Return  
Your Completed  
Warranty Card  
Immediately!***

# AMIGO

by Marjorie Spencer Darling

*I have a small electric cart  
I always have in tow,  
for every time I take a trip  
Amigo's sure to go.  
It followed me abroad this year,  
it simply is terrific!  
We went to the antipodes,  
and to the South Pacific.  
You, too, can take Amigo now  
and travel many places.  
No need for you  
to stay at home - Go!  
See new things and new faces.*

lieu of all other warranties, expressed or implied, and no person, agent or dealer is authorized to give any warranties on behalf of the Manufacturer, nor to assume for the Manufacturer any other liability in connection with any of its products unless made in writing and signed by an official of the Manufacturer.

This warranty provides you with specific legal rights, with the possibility of other rights, which vary depending upon your locality.

A three-year warranty is applicable outside the United States, with the exception of batteries, LED lights and switches, which have a six-month warranty.

## • FOR WARRANTY SERVICE

Contact: Service Department of AMI, 6693 Dixie Highway, Bridgeport, MI 48722, TOLL-FREE: 1-800-248-9131 during regular business hours (EST). For emergencies, contact your local Amigo Mobility Center<sup>®</sup>, Amigo representative, or after business hours (6 p.m. EST), call (517) 798-5634. There is a \$5.00 fee for this emergency phone line service.

If you have any further questions regarding your Amigo, need further assistance in troubleshooting a problem, or if your Amigo needs service or repair, please call the Amigo Service Department at 1-800-248-9131. A complete Service Guide and Electrical Troubleshooting Kit are available to you.

## • SMALL PARTS ORDERS

Amigo is committed to serving you quickly and efficiently. Yet, in today's economy, it can be expensive at times. The cost of ordering, preparing, packing, invoicing and shipping a part which cost \$1.00 to purchase, costs approximately \$7.00 to send out to you. This cost insures we have accurate records of parts ordered on your Amigo and gives you the added security of warranty coverage. We ask that you help us continue to serve you effectively and help keep the cost of our parts down. On parts orders less than \$7.00, please think about ordering an additional part or kit you've been wanting. This way, you save future shipping costs and we decrease any undue cost to you in the future. Thank you .

# Accessory Totes for Amigo PMAs

You can carry life's little necessities in style! Amigo now offers a complete line of tote bags that offer you several convenient options of where and how you want to carry things when you travel on your Amigo. The tote bags are made of a gray nylon mesh and have the Amigo logo imprinted on them.

*Basket Liner*  
.....  
Fits inside of a folding basket  
13" Wide, 9" Tall, & 7" Deep  
#8156 ... \$19.95

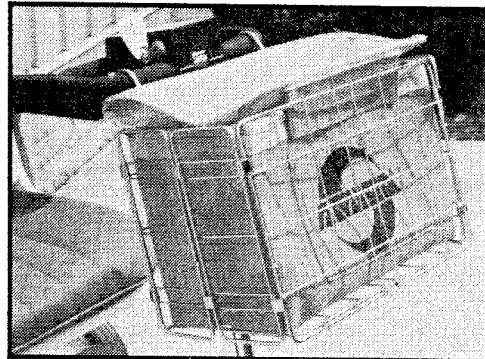

*Large Seat Tote*  
.....  
Attaches to the arms behind the seat  
16.5" Wide, 13" Tall & 4" Deep  
#8155 ... \$18.95



*Small Handle Tote*  
.....  
7.5" Wide by 8.5" Tall  
#8154 ... \$14.95

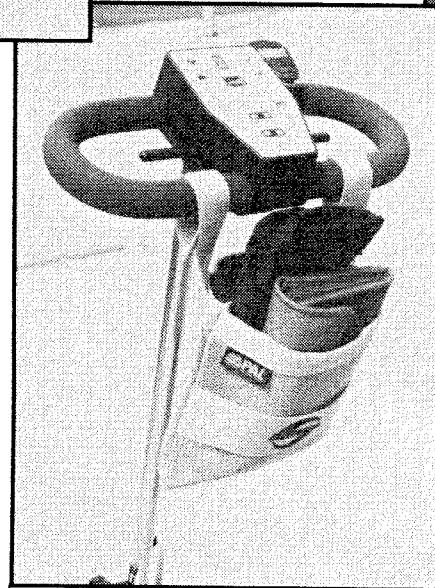



# AMIGO

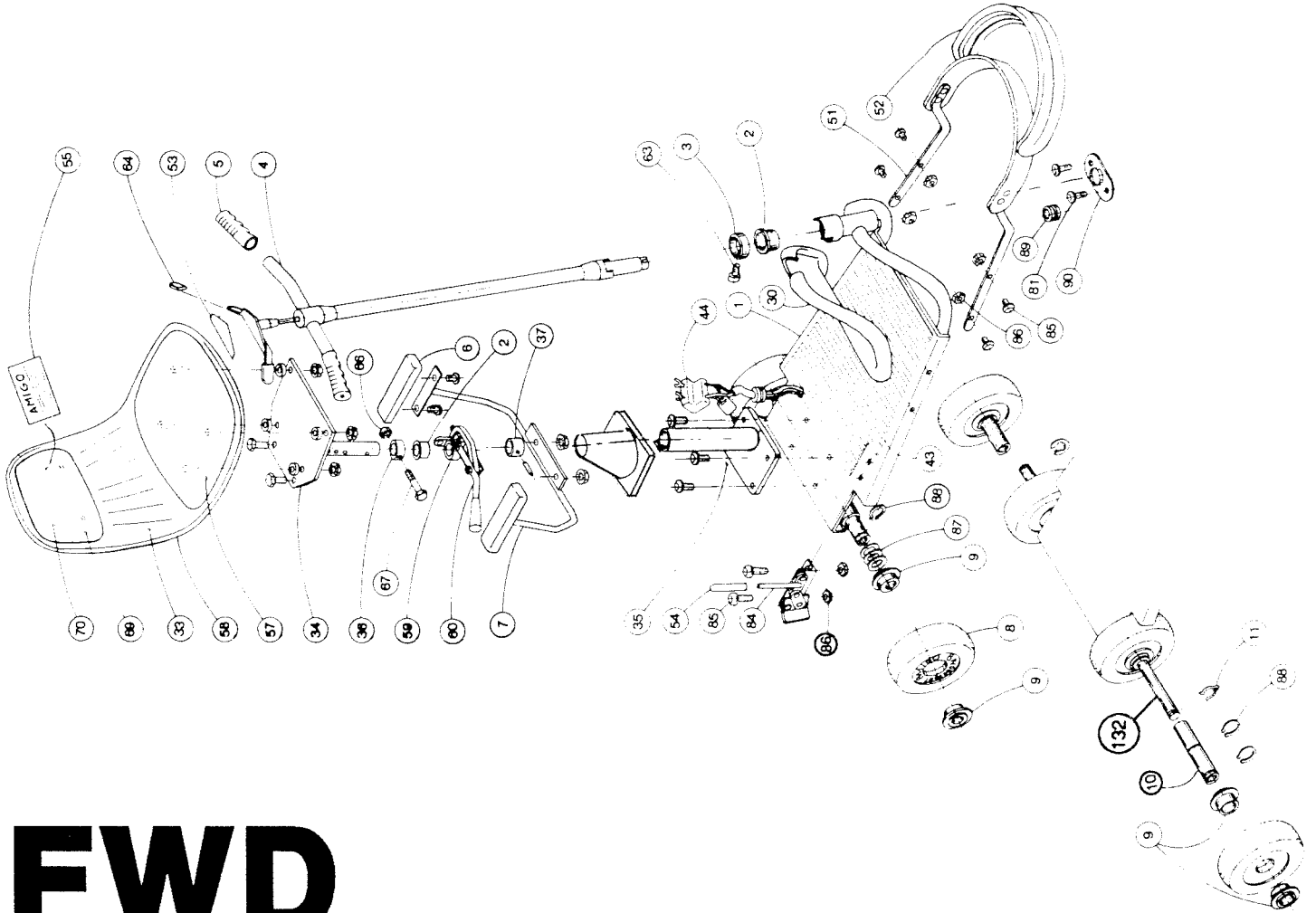

# FWD

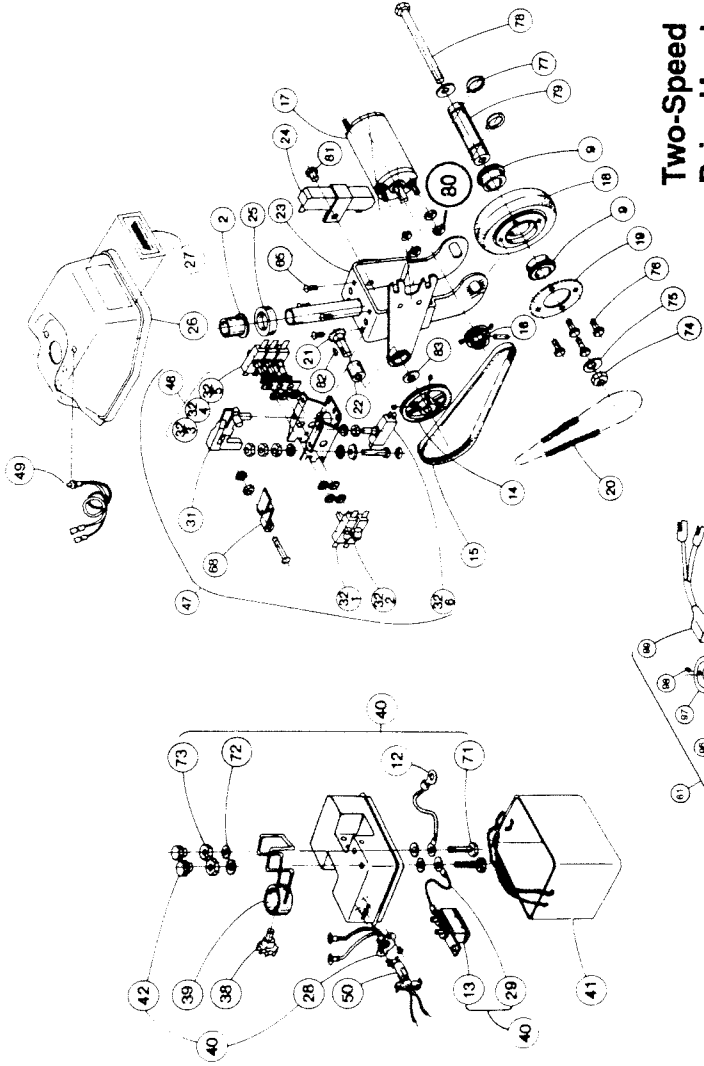

**Two-Speed  
Drive Head**

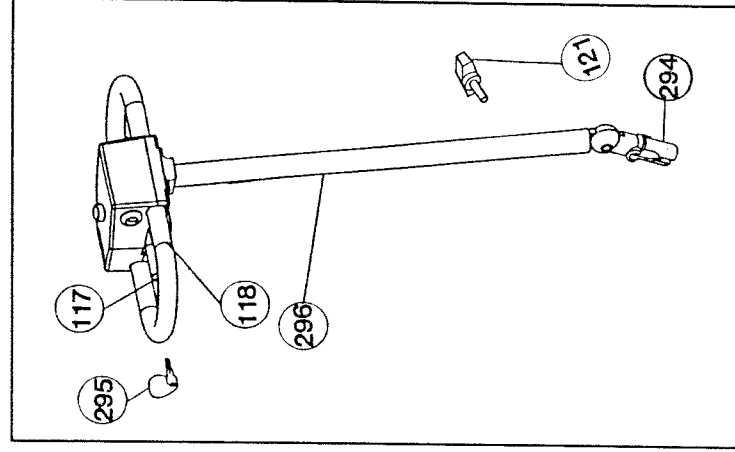

**Vari-Speed  
Drive Head**

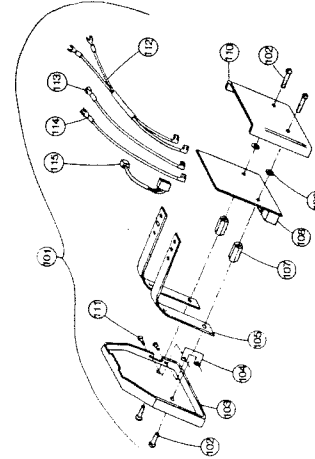
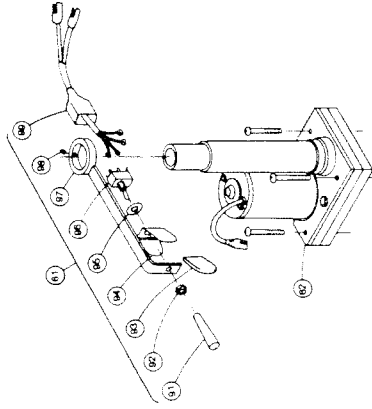

# Exploded View

# Amigo FWD Parts List

*We recommend using Amigo authorized parts.*

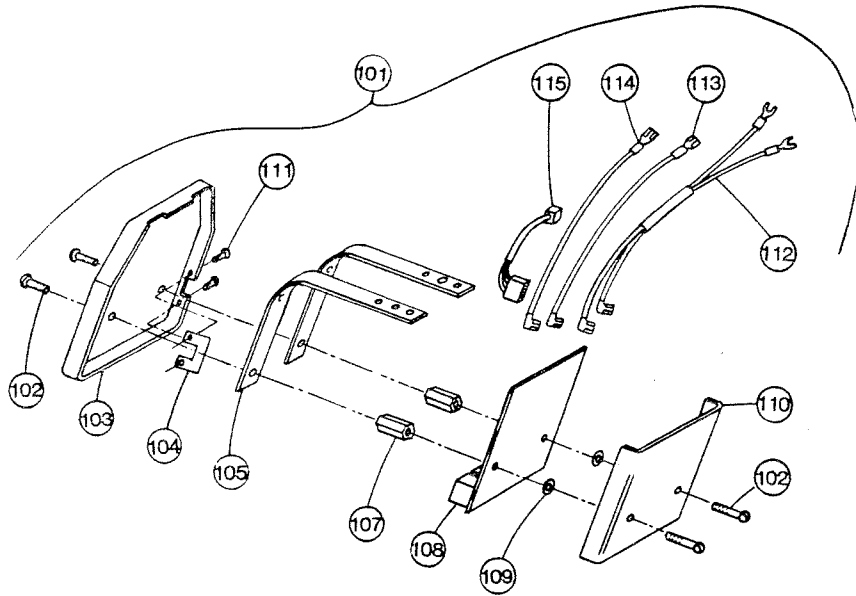

## Amigo FWD Vari-Speed Components

Ref#	Item#	Description
1	5676	Platform, Regular Painted
2	1025	Shoulder Bearing
3	1026	Collar, Retaining
4	100040	Handle Assembly, 24" (2-Speed Only) - (Includes #s 5, 53, 64 )
5	1185	Handlebar, Grips (Pair)
6	210010	Armpad Replacement - Pair, Regular
7	210000	Armrest Assembly (Standard) - (Includes #6)
8	4790	Wheel Assembly - 6" Rear (Includes #9)
9	1055	Bearing - Wheel
10	215050	Bushing, Dual Wheel & Pneumatic - (Includes #88)
11	1077	Hairpin Clip
12	1213	White Wire Battery Top
13	100592	Circuit Breaker Assembly, 30-Amp
14	100273	Pulley, Driven, 48-Tooth
	100275	Pulley, Driven, 60-Tooth - (Includes #s 82, 83)
15	100293	Belt, 170 XL
	100295	Belt, 180 XL
16	100300	Pulley, Drive w/Pin - (All Models)
17	100317	Motor Assembly, Two Speed: - Model 103 & 105 (Includes #s 16, 48)
	100318	- Model 101 (Includes #16)
18	100372	Front Wheel Assembly - (Includes #s 9, 19, 76, 77, 79)
19	100430	Sprocket, Front Wheel
20	100451	Chain, 68-Link
	100452	Chain, 66-Link
21	100465	Jackshaft, 9-Tooth

	100466	Jackshaft, 13-Tooth - (Includes #s 82, 83)	38	2157	Battery Bracket Holding Knob
22	1035	Jackshaft Bearing - 2119 UP	39	100730	Battery Holding Bracket - (Includes #38)
23	100481	Fork Assembly - Front, (Includes #22)	40	100740	Battery Case Top - U1 Assembly - (Includes #s 12, 28, 29, 71, 72, 73)
24	100510	Resistor, Low-Speed, w/Bracket - (Includes #81)	41	100750	Battery Case Bottom
25	1024	Steering Column Spacer	42	1188	Terminal Knob, Battery
26	100541	Wheelhousing - w/LED Hole, (Includes #s 27, 89)	43	3712	Floormat (8/83)
27	1296	Label, Wheelhousing	44	100800	Wire, Harness for Standard Platform
28	100580	Charging Plug & Wire Assembly - Female	45	1127	Wire, Drive Head Two-Speed (Not Shown)
29	3451	Wire & Circuit Breaker Assembly - U1 or 24C, (Includes #13)	46	100830	Switch Pack Assembly - (Includes #s 32-3, 32-4, 32-5)
30	100610	Front Cowl (8/83)	47	100850	Switch Frame Assembly, <i>2-Speed Only</i> - (Includes #s 31, 32-1, 32-2, 32-6, 46, 68)
31	3584	Switch Bar	48	100880	Brake Resistor Model 103 & 105 - (Not Shown)
32-1	100651	Switch, S1 w/capacitor	49	100935	LED Light (8/83)
32-2	100652	Switch, S2 w/capacitor	50	100940	Charging Plug & Wire Assembly - Male
32-3	100653	Switch S3 w/capacitor	51	273000	Bumper Assembly (Optional) - (Includes #s 52, 85, 86)
32-4	100654	Switch, S4 w/capacitor	52	3002	Bumper, Rubber Replacement - 22170 UP
32-5	100655	Switch, S5	53	1930	Label, Thumb Control Lever
32-6	100656	Switch, S6	54	6016	Grip, Vinyl Brake Lock
33	271250	Seat, Padded Naugahyde - (Optional)	55	1295	Label, Seat Back
	270250	Seat, Padded Nilo (Optional) - (Includes #s 55, 57, 58, 69, 70)	57	271011	Pad, Naugahyde Seat (Optional)
	100660	Seat, Fiberglass (Standard) - (Includes #s 55)	58	270011	Pad, Nilo Seat (Optional)
34	100670	Upper Seat Post - (Includes #s 2, 37, 66, 67)	59	270505	Moulding, Padded Seat
35	100688	Lower Seat Post		267005	Seat Lock Casting
36	100690	Stem Collar w/Bolt & Nut - (Includes #s 66, 67)			
37	100710	Bearing, Lower w/Pin			



60	267000	Seat Lock Assembly - RH (Includes #59)	87	1069	Washer, .65 ID Shim
	267500	Seat Lock Assembly - LH (Includes #59)	88	1079	Retaining Ring, Wheel
61	341525	Travel Switch Assembly - (Includes #'s 91 - 99)	89	1291	Grommet, D/H
62	341075	Power Seat Lift Component w/o Amigo - 12-Volt	90	100620	Flange, Wheelhousing - (Includes #81)
63	6162	Screw, 1/4 - 28 x .31 Screw	91	1567	Switch Extension
64	1366	Covers, Pair of Thumb Tab	92	2296	Nut, 15 - 32 Hex Jam
65	2404	Screw, 10 - 32 x .50 Flat HD	93	3019	Cover, Switch Guard
66	1253	Nut, 5/16 - 18 Hex Keps	94	341510	Guard, Switch (Includes #93)
67	1450	Screw, 5/16 - 18 x 2.50 Hex HD	95	4179	Washer, 1/2 ID Int. Tooth Lock
68	100820	Brake Switch Lever w/Screw	96	341035	Switch PSL (Includes #s 95, 92)
69	271012	Pad, Naugahyde Back - (Optional)	97	341526	Holder, Travel Switch (Includes #98)
	270012	Pad, Nilo Back (Optional)	98	5379	Screw, 1/4 - 20 x .312 Set
70	1546	Screw, 10 - 24 x .375 RD HD	99	1556	Boot, Switch
71	1193	Screw, 1/4 - 20 x .75 Hex HD	101	6695	Controller & Bracket Assembly
72	2501	Washer, 1/4 ID Cone Lock	102	5510	Screw, 8 - 32 x .50 RD HD
73	1194	Nut, 1/4 - 20 Hex Jam	103	6653	Cover, (11/90) Controller Rear
74	2237	Nut, 3/8 - 24 Hex	104	6654	Bracket, Mounting Plug
75	1189	Washer, 3/8 ID Cone Lock	105	5467	Strap, Vari-Speed Controller
77	1040	Retaining Ring, Centering Tube	107	5281	Nut, 3/8 x 3/16 x 1 LG Hex
78	2236	Screw, 3/8 - 24 x 3.75 Hex HD	108	5469	Circuit Board, (2/88) Vari-Speed
79	100420	Centering Tube (Includes #77)	109	2354	Washer, Insulated Shoulder
80	1264	Nut, 10 - 32 Hex Keps	110	6266	Cover, (2/88) Controller Front
81	1184	Screw, 1/4 - 20 x .50 Truss HD	111	6699	Screw, #4 - 40 x .50 Pan HD
82	1132	Woodruff Key, Driven Pulley	112	5473	Wire, (2/88) Vari-Speed Power
83	1270	Washer, Spacer Thrust	113	5408	Wire, Blue Controller
84	285000	Brake Lock, Right, Platform	114	5406	Wire, Orange Controller
	285500	Brake Lock, Left, Platform - (Includes #s 54, 85, 86)	115	6655	Wire, FWD Junction
85	1178	Screw, 1/4 - 20 x .625 Button HD	117	5719	Cap, Adjustable Handle Tab, Vinyl
86	1167	Nut, 1/4 - 20 Hex Keps	118	7419	Grip, MPC Adjustable Handle Vinyl
			120	3973	Screw, 10 - 32 x .50 Soc But HD
			121	7279	Knob, T 5/16 - 18 x 7/8"
			132	2133	Axle, Extended
			294	7713	Articulating Clamp
			295	7997	Key, with Extension
			296	8244	Handle, FWD Vari-speed

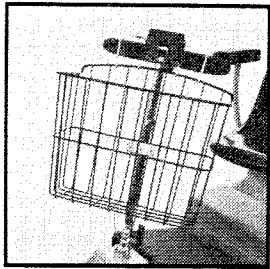

### ■ Vinyl Coated Basket

Within easy reach and your direct view, the Amigo wire basket provides a safe storage space for all of your necessities. The wire mesh has a black vinyl coating, which covers any sharp edges and offers an attractive look.

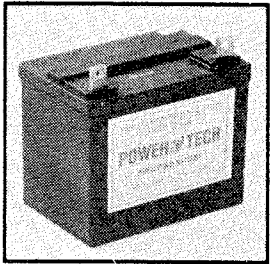

### ■ Battery

Have all those miles taken a toll on your battery? Order a new battery to keep on hand ... just in case! Comes with a full six-month warranty.

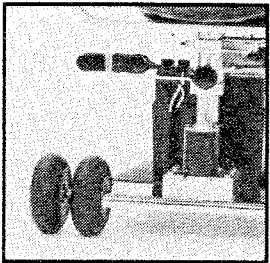

### ■ Power Seat Lift

With this lift on your Amigo, shelves and counters are easier to reach. Powered by the Amigo battery, the touch of a switch gives you a lift.

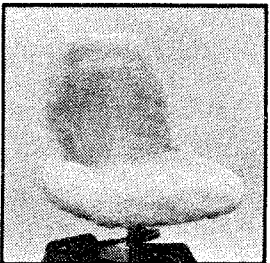

### ■ Sheepskin Cover

Add a touch of luxurious comfort to your Amigo with all natural sheepskin. It not only looks good, but it's soft, adds cushioning, and is extremely durable.

## Available Accessories for the Amigo FWD

*Any of these accessories shown here are available from Amigo Mobility International, Inc. The order can be placed through your local Amigo Representative, Amigo Mobility Center®, or by calling 1-800-248-9131. To help you save money when purchasing these items, please consider using the "Amigo Gold" referral program.*

### ■ #0718 Service Guide

This book provides a quick reference that allows you to begin to find the source of any service problems you may encounter.

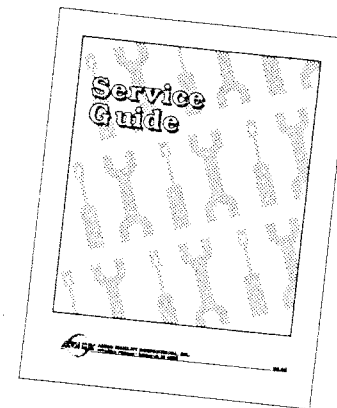

ACCESSORIES



# WIRING DIAGRAMS

## • Amigo FWD •

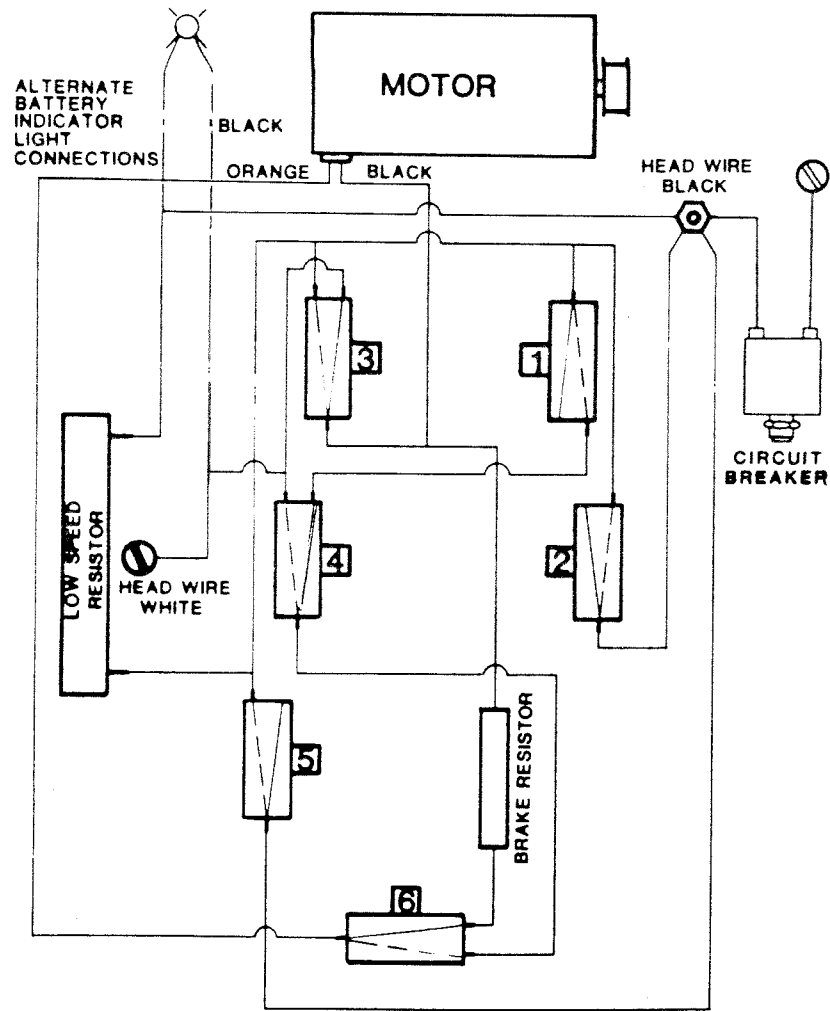

• Amigo FWD (Vari-Speed) w/Oval Handle •

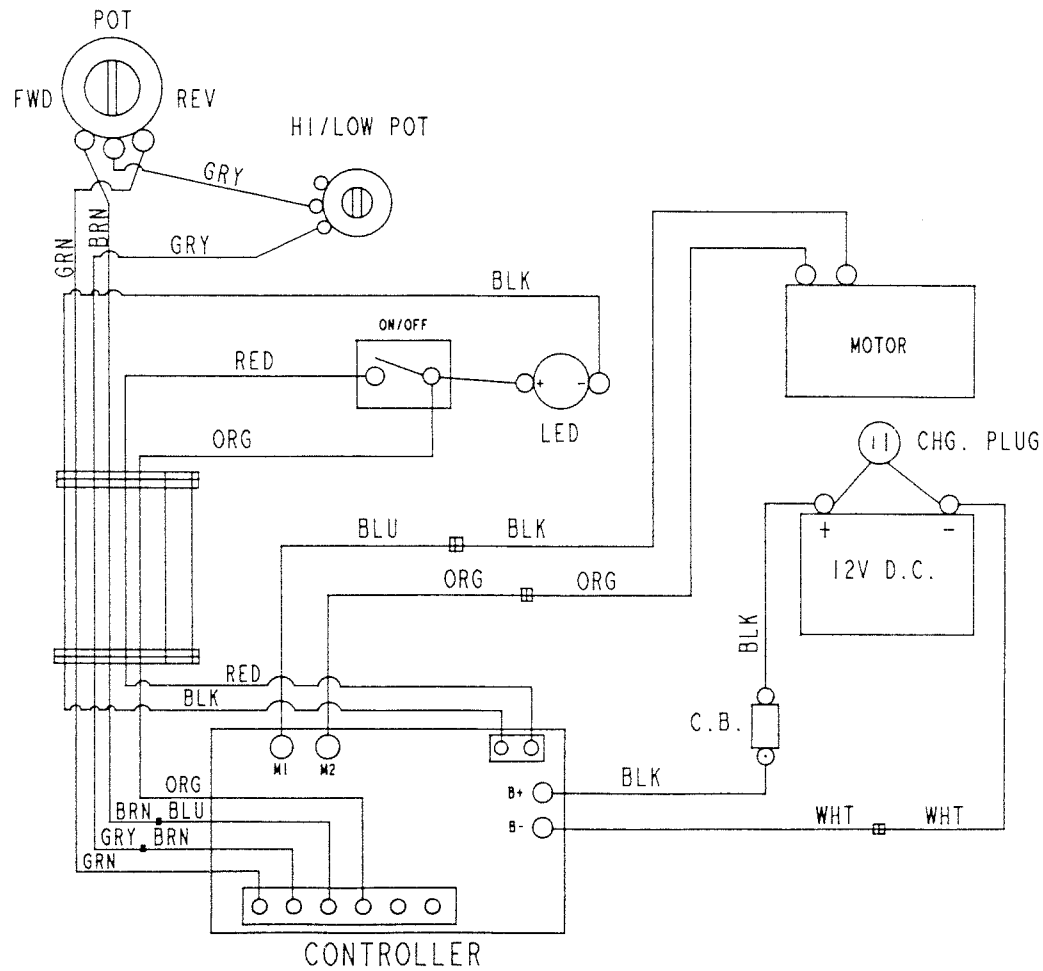

LIFT-ALL®



**H**aving an Amigo without owning a LIFT-ALL® is like stopping halfway through a great novel. You never know how much more exciting it can get. With a LIFT-ALL®, take your Amigo along no matter where you travel. The LIFT-ALL® is a compact and durable lift that works with almost any three-wheeled mobility aid available today. It is durable because of its all-steel construction, and compact because it folds out-of-the way when not in use. The LIFT-ALL® is easily installed and reinstalled in cars, vans and station wagons. This makes the LIFT-ALL® a "bestseller" among all available trunk lifts.

SAVE  
\$25



You can save \$25 on the purchase of a LIFT-ALL®. Fill out this coupon and redeem it at your nearest Amigo Mobility Center®, through your local Amigo representative, or send it directly to Amigo Mobility International, Inc. when you purchase your LIFT-ALL®. Expires 90 days from date of purchase.

Name \_\_\_\_\_

Address \_\_\_\_\_

City \_\_\_\_\_

State \_\_\_\_\_ Zip \_\_\_\_\_

Phone \_\_\_\_\_

Date Purchased \_\_\_\_\_

Amigo Purchased \_\_\_\_\_

Serial Number \_\_\_\_\_